

## KNX radio wall-transmitter 1gang/2gang flat quicklink

Order no.: 8565 x2 xx

## KNX radio wall-transmitter 1gang/2gang flat solar quicklink

Order no.: 8565 x1 xx

### Operating instructions

#### 1. Safety instructions

Electrical equipment may only be installed and assembled by a qualified electrician in accordance with the relevant installation standards, guidelines, regulations, directives, safety and accident prevention regulations of the country.

Failure to comply with these instructions may result in damage to the device, fire or other hazards.

Button cells do not belong in children's hands! If button cells are swallowed, seek immediate medical assistance.

**Danger of explosion! Do not throw batteries in fire.**

**Danger of explosion! Do not recharge batteries.**

The radio transmission is not suitable for safety or alarm applications.

These instructions are an integral component of the product and must be retained by the end user.

#### 2. Design and layout of the device

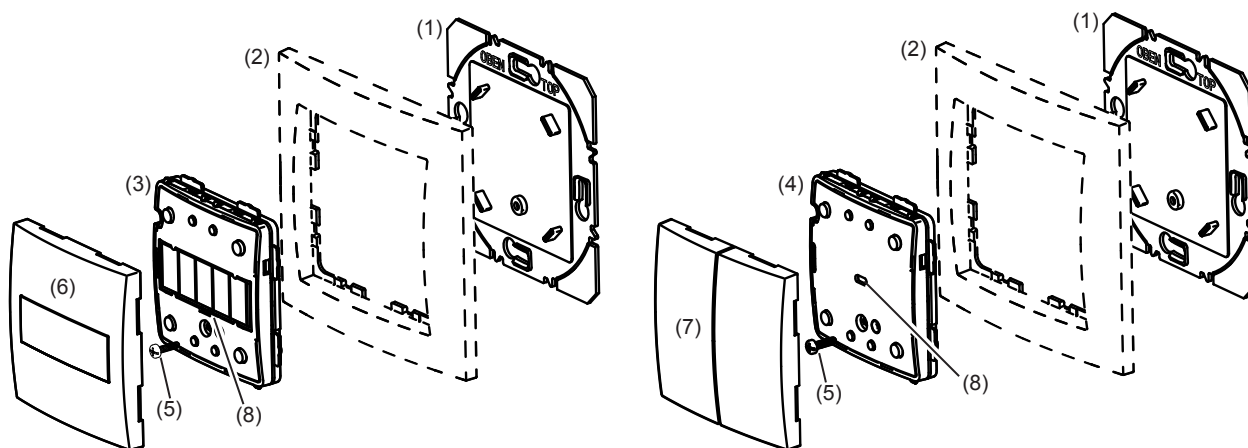

Figure 1: Design and layout of the device

- (1) Supporting plate
- (2) Frame (not within scope of delivery)
- (3) Exemplarily Radio wall-transmitter 1gang flat solar quicklink
- (4) Exemplarily Radio wall-transmitter 2gang flat quicklink
- (5) Screw for dismantling protection
- (6) Button design cover 1gang
- (7) Button design cover 2gang
- (8) Transmission status LED

### 3. Function

#### System information

This device is a product of the quicklink system, in which installation devices communicate via radio signals.

Quicklink stands for a configuration mode in which the function-related connection between transmitters and receivers is set on the device through buttons and displays without further tools.

All devices configurable by quicklink can be operated together in one system.

This device complies with the R&TTE directive 1999/5/EG. The declaration of conformity and further system information can be found on our internet site [www.berker.de](http://www.berker.de).

The device may be operated in all EU and EFTA states.

#### Correct use

- Flat surface installation and extension of combinations.
- Only suitable for use in indoor areas with no drip and no spray water.
- The device has been laid out for smaller applications in which a maximum 20 devices are allocated.

#### Product characteristics

- Functions for remote control, scenes, control switches via radio signals.
- Transmission status LED as display of radio reception; as required, when battery is too weak or a configuration is absent.

### 4. Operation

#### Allotting of channels to inputs of wall-transmitter

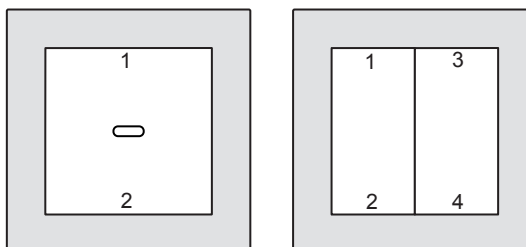

Figure 2: Allotting of channels to inputs

#### Transmit radio command

The push-button operation areas are freely configurable; operation is dependent on the configuration (Table 3).

- Press a push-button operation area, e.g. 1, to send a radio command.  
The transmission status LED (8) lights up to confirm.

### Transmission status LED display

After operation, the transmission status LED on the 1gang wall-transmitter lights up through a lens and on the 1gang wall-transmitter and on the 2gang wall-transmitter, through the gap between the two push-buttons.

Transmission status LED	Severity
Blinking orange	Button not configured
Blinking green / blinking green	Radio command sent / radio command received
1 x blinking green	Radio command sent to timer
1 x blinking green / 1 x blinking red	Radio command sent / radio command not received (with at least 1 device)
Red, flickering for 2 seconds	Battery weak; replace

Table 1

## 5. Information for electricians

### Overview of the operating elements beneath the design cover

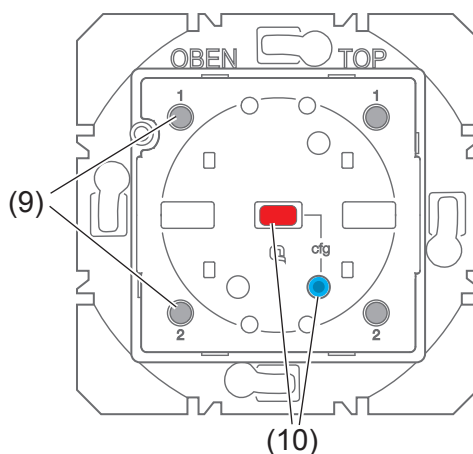

Figure 3: Wall-transmitter with battery

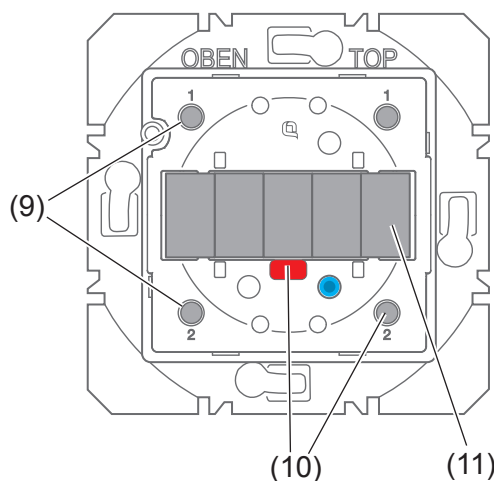

Figure 4: Wall-transmitter solar

(9) Press-activation point of the push-button operation area

(10) **cfg** input with **cfg** LED or transmission status LED

(11) Solar cells

## 5.1 Installation

### Selecting installation location

An average daily brightness of approx. 300 lux for 6 hours at the operation site is to be guaranteed for the wall-transmitter solar.

-  If the recommended brightness may not be guaranteed over a long period, subject product to light for a while. Press any button then to restore device to normal mode.

A minimum distance between the transmitter and corresponding receiver of about 1 m must be maintained.

A minimum distance to electronic devices which emit high frequency signals such as computers, electronic transformers or microwave devices of approx. 0.5 m must be maintained.

Mounting on or close to metal surfaces may cause impairment of the function.

Take material penetration into account. The range of the system can be optimised by selecting the best possible installation site:

Material	penetration
Wood, plaster, plasterboard, uncoated glass	approx. 90 %
Brick, press boards	approx. 70 %
Reinforced concrete, underfloor heating	approx. 30 %
Metal, metal grids, aluminium laminates, coated glass	approx. 10 %
Rain, snow	approx. 1 ... 40 %

Table 2: Material penetration

### Assembly of the device (Figure 1)

- Glue or screw supporting plate (1) to an even surface or screw to a wall box. Thereby the labelling Top/Up must be on top.
- For battery-operated wall-transmitters, insert batteries (see figure 3)
- Place wall-transmitter (3 or 4) together with frame (2) on the supporting plate (1) and establish dismantling protection with screw (5).
- After the configuration, click design cover (6 or 7) into place on wall-transmitter (3 or 4).



#### **WARNING!**

**Danger of chemical burns.**

**Batteries can burst and leak out.**

### Insertion of battery

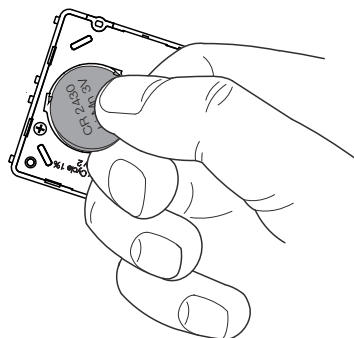

Figure 3: Insertion of battery

- Insert battery on the plus contact of the battery holder and press to click into place. Thereby pay attention to the polarity: the positive terminal of the battery should be upwards.

### Changing battery

- Unscrew dismantling protection and remove device (see Assembly of device).

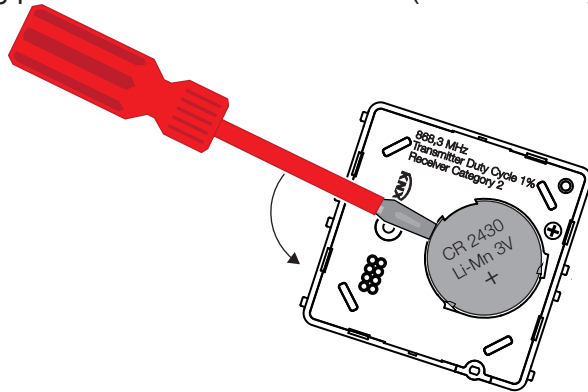

Figure 4: Remove battery

- Carefully lever out the empty battery with a screwdriver.
- Insert new battery on the plus contact of the battery holder and press to click into place. Thereby pay attention to the polarity: the positive terminal of the battery should be upwards.
- i** Only replace empty batteries with an identical or equivalent type.
- i** Keep battery and battery holder contacts clean and free of grease.

### Radio configuration quicklink

The radio configuration sets the functional connection between commanding (transmitters) and function-executing (receivers) radio components. In so far wireless e.g. central unit, group, extension unit and time controls can be realised.

The following can be configured:

- Radio commands to control other receivers
- Functions which are executed when the radio commands are received
- i** The top and bottom push-button operation area can be configured differently.
- i** For configuration by means of Hager connection device TX100 or ETS, additional functions are available (see operating instructions for TX100 or application description for ETS).

### Wall-transmitter radio commands

The radio wall-transmitter can activate the following functions on receivers (table 3). The details of the function can vary depending on the receiver being used:

Configurable functions		Function resulting from transmitter operation, notes
▲	Move UP, stop	Short-press < 0.4 s: slat adjustment/stop Long-press > 0.4 s: move UP, self-retaining= 2 min.
▼	Move DOWN, stop	Short-press < 0.4 s: slat adjustment/stop Long-press > 0.4 s: move DOWN, self-retaining= 2 min.
	Memory function	Long-press > 5 s: Activates execution of the memory function Short-press: Deactivates execution of the memory function Recording cannot be activated by radio command.
	ON/OFF single-surface operation	Short-press: switch on/off
<b>on</b>	ON	Short-press: switch-on
<b>off</b>	OFF	Short-press: switch-off
	NO contact (contact duration)	Switching on for the duration of the actuation (push-button functionality)

	ON/OFF, dimming UP/DOWN single- surface operation	Short-press: < 0.4 s: switch-on with switch-on brightness-level / switch-off Long-press > 0.4 s: alternating dimming to maximum or minimum
+	Dimming ON, UP	Short-press: < 0.4 s: switch-on with switch-on brightness-level Long-press > 0.4 s: dimming to maximum brightness level
-	Dimming OFF, DOWN	Short-press: < 0.4 s: switch-off Long-press > 0.4 s: dimming to minimum brightness-level
	Scene 1	Short-press < 0.4 s: activate scene Keep pressed > 5 s: save scene
	Scene 2	
	Timer	Short-press: switch on for the time set on the receiver

Table 3: Configurable functions

### Configuration of radio wall-transmitter

As an example, down below there is a description of configuring the radio wall-transmitter with receivers for which the **cfg** LED and **fct** LED provide the supported displays (table 4). Differing configuration displays, such as for receivers with display, are to be taken from the receiver operating instructions.

- Configurations of scenes, time settings and deletion of configuration are to be taken from the receiver operating instructions.

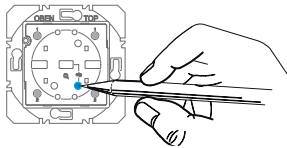
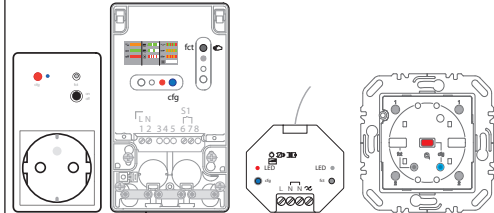
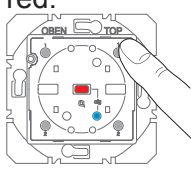
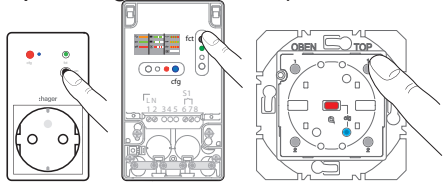
Handling step	Result
<i>Start configuration</i>	
<p>Briefly press the <b>cfg</b> input on the radio wall-transmitter.</p>  <p> If there is no further operation, the configuration is automatically ended after 10 minutes.</p>	<p>The <b>cfg</b> LEDs on the wall-transmitter and the receivers within radio range light up in red colour.</p> 
<i>Select transmitter button</i>	
<p>Press the button of the push-button operation area for which a command should be configured.</p> 	<p>The <b>cfg</b> LED on the radio wall-transmitter blinks for 1 second. Afterwards the radio wall-transmitter and receiver are in configuration mode and the <b>cfg</b> LEDs light up. If already configured, the <b>fct</b> LED of the receiver indicates the current function configured with the button.</p>
<i>Select function at receiver</i>	
<p>Press the <b>fct</b> input on the receiver again briefly to select the desired function (see the receiver operating instructions).</p> 	<p>After each actuation, the <b>fct</b> LED indicates a function.</p> <p> If the button of the push-button operation area is already configured with a function in a different receiver and/or the configured function is part of a group control, this function needs to be configured only. To change a function, the existing configuration needs to be deleted and the new one configured.</p>

<i>Confirming function on receiver</i>	
To save the allocation of command and function, hold the <b>fact</b> input on the receiver pressed longer than 2 seconds.	<p>The <b>cfg</b> LED blinks. After a successful saving, the <b>fact</b> LED signals the saved function.</p> <p> A quick blinking of the <b>cfg</b> LED indicates a combination that is not possible or an error.</p>
<i>Finish configuration</i>	
<p>Briefly press the <b>cfg</b> input on the radio wall-transmitter.</p> 	<p>The <b>cfg</b> LEDs on the radio wall-transmitter and all receivers within radio range are extinguished. The radio command for the radio wall-transmitter has been configured.</p>

Table 4: Configuration of the radio wall-transmitter as a transmitter

## 6. Appendix

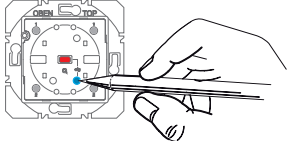

Immediately remove empty batteries and dispose of in an environmentally acceptable manner. Do not throw away batteries in household waste. The local authorities provide information about environmentally-friendly disposal. According to statutory requirements, the end consumer is obliged to return used batteries.

### 6.1 Technical data

Radio frequency	868.3 MHz
Radio protocol	KNX radio
quicklink logic functions	max. 20 transmitters/ receivers
Receiver category	2
Transmitter duty cycle	< 1%
Radio transmission range (free field)	100 m
Transmission power	< 10 mW
Degree of protection	IP 20
Relative humidity	0 ... 65 % (no condensation)
Ambient temperature	-5 ... +45 °C
Storage/transport temperature	-20 ... +60 °C
Assembling height	14 mm

#### Radio wall-transmitter flat quicklink

Rated voltage	3 V=
Battery type	1 x Lithium CR2430
Battery service life	approx. 5 years

The Declaration of Conformity can be taken from our Internet site.

### 6.2 Warranty

We reserve the right to realise technical and formal changes to the product in the interest of technical progress.

Our products are under guarantee within the scope of the statutory provisions.

If you have a warranty claim, please contact the point of sale.