

Switch / shutter actuator 16/8gang 16A RMD Switch / shutter aktuator 8/4gang 16A RMD

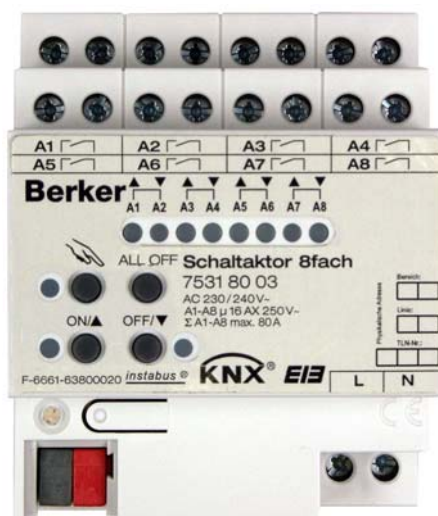

Date of issue: 07.09.2010
63790120.114

Table of Contents

1	<u>Product definition</u>	<u>3</u>
1.1	Product catalogue	3
1.2	Function	3
2	<u>Fitting, electrical connection and operation</u>	<u>4</u>
2.1	Safety instructions.....	4
2.2	Device components.....	5
2.3	Fitting and electrical connection.....	6
2.4	Commissioning.....	11
2.5	Operation	14
3	<u>Technical data.....</u>	<u>19</u>
4	<u>Software information.....</u>	<u>22</u>
4.1	Software specifications	22
4.2	Software "Switching, shutter 2078x2 / 2080x2"	24
4.2.1	Scope of functions	24
4.2.2	Software information.....	25
4.2.3	Object table.....	26
4.2.4	Functional description.....	34
4.2.4.1	Description of channel-independent functions	34
4.2.4.2	Channel-oriented functional description.....	47
4.2.4.3	Delivery state	122
4.2.5	Parameters	123

1 Product definition

1.1 Product catalogue

Product name: Switch / shutter actuator 16/8gang 16A RMD
Switch / shutter actuator 8/4gang 16A RMD
Use: actuator
Design: REG (rail-mounted device)
Order no.: 4/8gang: 7531 80 03 / 8/16gang: 7531 00 02

1.2 Function

The switching/shutter actuator receives telegrams from sensors or other controls via the KNX / EIB and switches electrical consumers. The outputs of the actuator can be configured in the ETS either for the shutter mode or alternatively for the switching mode, with mixed operation of the modes mentioned on the device itself remaining possible. In shutter mode the switching/shutter actuator uses its relay contacts for switching electrically operated blinds, shutters, awnings, venting louvers or similar devices for 230 V AC mains voltage. In the switching mode the actuator switches electrical consumers such as lighting fixtures or also extra low voltages.

Each relay output is equipped with mains-operated monostable switching relays so that the preferred contact positions are maintained also during bus voltage failure.

The controls (4 pushbuttons) on the front panel of the device permit switching the relays on and off by hand in parallel with the KNX / EIB even without bus voltage or in a non-programmed state. This feature permits fast checking of connected motors for proper functioning.

The functionalities that can be preset with the ETS independently for each output channel include in shutter mode, for instance, separately parameterizable moving times, enlarged feedback functions, assignment to up to five different safety functions, a sun protection function adapted to a great variety of requirements and the incorporation into scenes or forced-position applications. Centralized control of all outputs is also available. The functionalities in switching mode include among other things extensive timing functions, logic operations, scenes, disabling or forced control functions and an enlarged range of response telegrams. Centralized switching of all outputs is also available. Moreover, the preferred states of the relays in case of bus voltage failure or bus / mains voltage return and after ETS programming can be preset separately.

For project design and commissioning of this device it is recommended to use the ETS3.0d. The advantages with regard to downloading (shorter loading times) and parameter programming are available only if this new ETS patch version or later versions are used. For the ETS2 and older versions of the ETS3 a separate product database is available.

The switching/shutter actuator has its own mains supply independent of the connected drives or loads. For actuation of the outputs, the mains supply must always be on. The device electronics are supplied from the bus voltage or from the mains voltage. The device is designed for being mounted on DIN rails in closed compact boxes or in power distributions in fixed installations in dry rooms.

2 Fitting, electrical connection and operation

2.1 Safety instructions

Electrical equipment must be installed and fitted only by qualified electricians. Observe the current accident prevention regulations.

Failure to observe any of the installation instructions may cause damage to the device and result in fire and other hazards.

Before working on the device or before replacing any connected loads, disconnect the supply voltage (by cutting out the circuit breaker) to avoid the risk of an electric shock.

The switching/shutter actuator is not suited for safe disconnection of the mains.

For parallel connection of several drives to an output it is indispensable to observe the corresponding instructions of the manufacturers. There is otherwise risk of irreparable damage to the drives.

Use only blinds/shutters with mechanical or electronic limit switches. Check the limit switches for correct adjustment.

Do not connect mains voltage and SELV/PELV circuits to the same switching/shutter actuator.

Do not connect three-phase AC motors to the actuator.

Make sure during the installation that there is always sufficient insulation between the mains voltage and the bus. A minimum spacing of 4 mm must be ensured between bus wires and mains conductors.

Do not open the device and do not operate it outside the scope of the technical specifications.

2.2 Device components

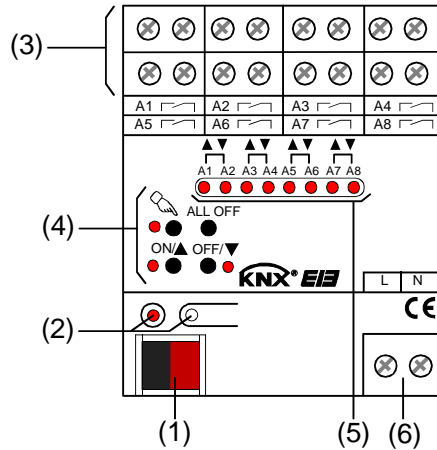

Dimensions:
width (W):
72 mm (4 TE)
height (H):
90 mm
depth (D):
70 mm

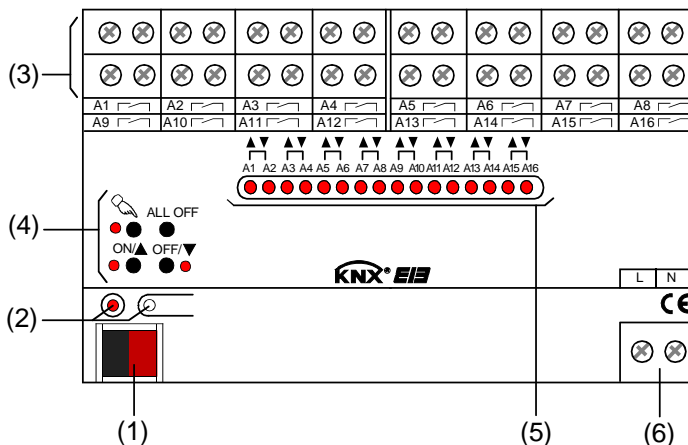

Dimensions:
width (W):
144 mm (8 TE)
height (H):
90 mm
depth (D):
70 mm

- (1): KNX/EIB bus connection
- (2): Programming button and programming LED (red). The programming LED flashes slowly when the safe-state mode is active.
- (3): Screw terminals (Ax,) for connection of the different loads.
- (4): Keypad for manual control with status LED.
- (5): Output state LEDs with travel direction indicator or for indication of the switching states (1 LED per output):
LED off: contact open,
LED on: contact closed (in shutter mode: upward travel "▲" or downward travel "▼"),
LED flashing slowly: output controlled manually,
LED flashing fast: output disabled by manual control.
- (6): Mains voltage terminal for power supply to the device electronics.

2.3 Fitting and electrical connection

**DANGER!**

Electric shock in case of accidental contact with live parts. Electric shocks can be fatal. Before working on the device, cut out the mains supply and cover up live parts in the surroundings.

**DANGER!**

Electric shock in all SELV/PELV circuits, if mains voltage consumers are connected together with SELV/PELV consumers to the same actuator. Electric shocks can be fatal. Risk of irreparable damage to all devices connected to SELV/PELV sources.
Do not connect SELV/PELV/FELV consumers to the actuator!

**CAUTION!**

Inadmissible temperature rise in the event of device overload. The device itself and the connected wires may be damaged at the terminals. The maximum load current rating per device must not be exceeded (cf. Technical Data). Neighbouring outputs must not be loaded with more than 20 A max.

**CAUTION**

Risk of irreparable damage if several drives are connected in parallel to one output. Limit switch contacts can weld together and drives, blinds/shutters and the shutter actuator can be irreparably damaged.
Observe the manufacturer's instructions and use isolating relays, if necessary.

Fitting

- Fit the device by snapping it onto a mounting rail in acc. with DIN EN 60715. The screw terminals for the outputs should be at the top.
- ⓘ A KNX / EIB data rail is not required.
- ⓘ Observe the temperature range (-5 °C ...+45 °C) and ensure sufficient cooling, if necessary.

Connecting the power supply for the device electronics

- Connect the bus (standard bus terminal) and the mains voltage as shown in Fig. 1 (wiring example).

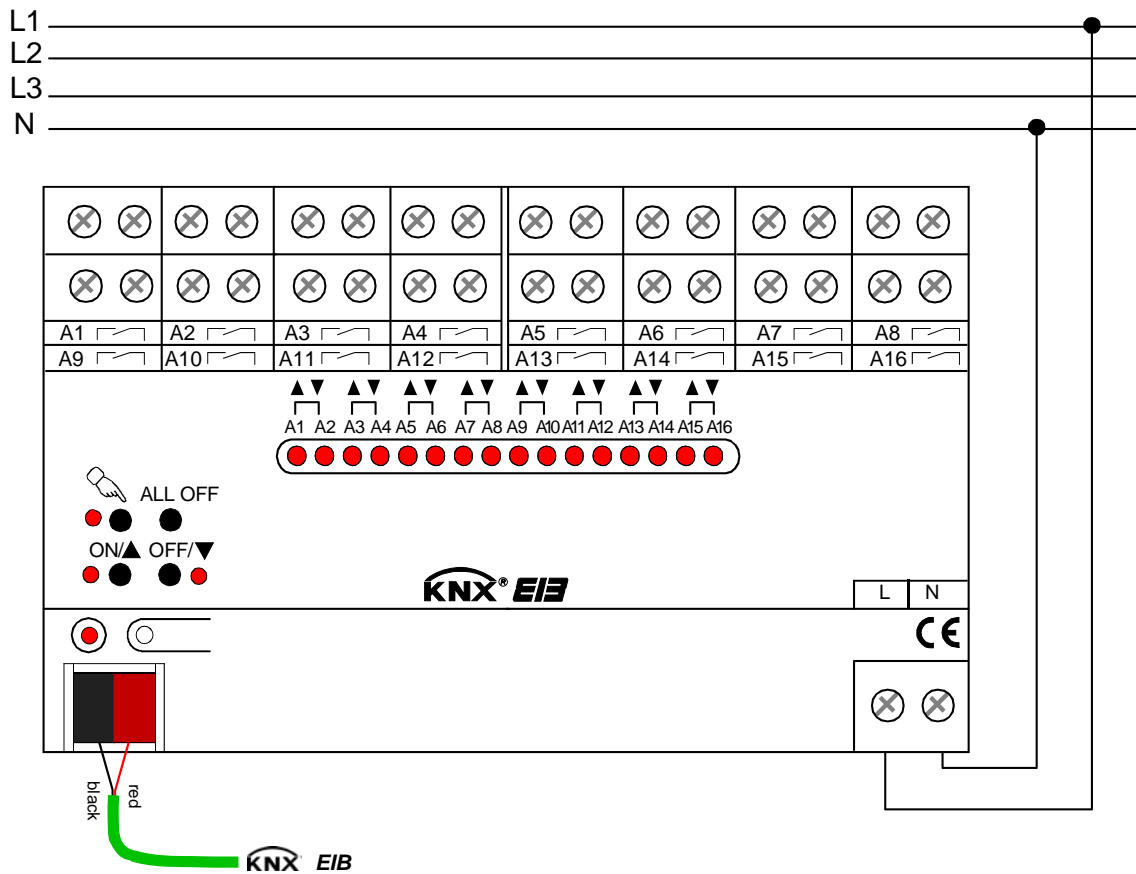

Fig. 1: Electrical connection of mains voltage

- ❗ The device can be connected to any of the phase conductors (L1, L2, L3).
- ❗ For actuation of the outputs – even in the manual control mode – the mains supply must be on. The device electronics (BCU with application program) are supplied with power from the bus or from the mains.
- ❗ The connection of drives in the shutter mode or of loads in the switching mode is described on the following pages.

Connecting the device for 230 V drives in the shutter mode

In the shutter mode, two neighbouring relay outputs constitute a blind/shutter output, with the left relay outputs (A1, A3, ...) controlling the UP direction (▲) and the right ones (A2, A4, ...) the DOWN direction (▼).

For this purpose, the shutter actuator must have been programmed in the ETS for blind/shutter operation of the corresponding output channel (1 x blind/shutter output) (this is also the setting in the as-supplied state of the actuator).

- Connect the drives as shown in Fig. 2 (wiring example).

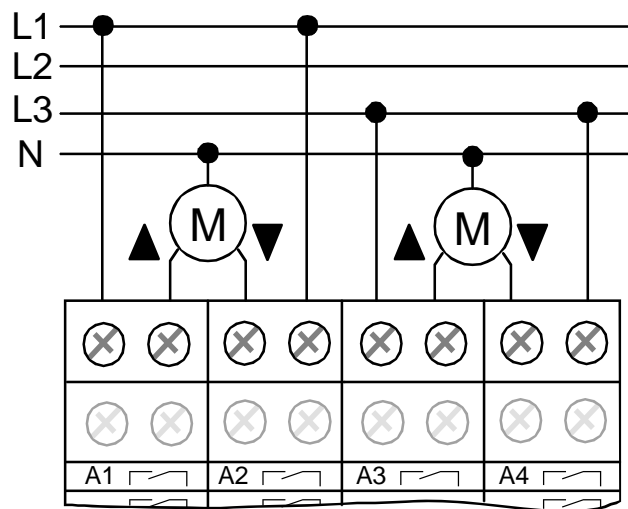

Fig. 2: Electrical connection for 230 V drives in shutter mode

- ⓘ Observe the admissible load ratings (cf. 'Technical data').
- ⓘ The device can be used with different phase conductors (L1, L2, L3).
- ⓘ Venting louvers must be connected in such a way that they open in travel direction "UP - ▲" and close in travel direction "DOWN - ▼".

Connecting the device for electrical loads in the switching mode

In the switching mode, the outputs can be controlled independently of one another.

The switching/shutter actuator must have been programmed in ETS for switching operation of the corresponding output channel (2 x switching output).

- Connect the loads and the bus line as shown in fig. 3 (connection example).

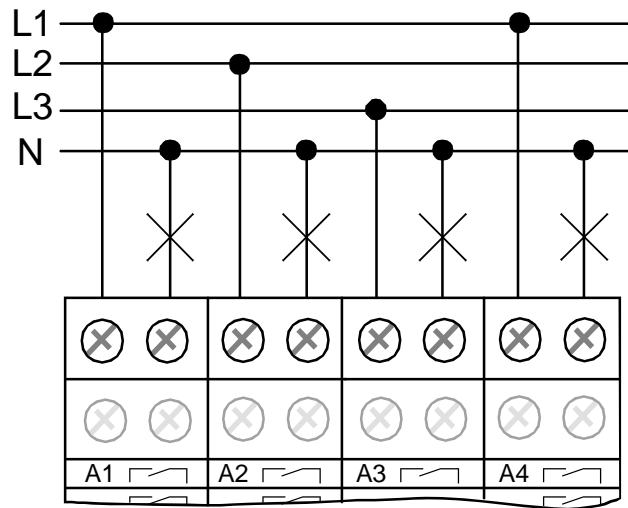

Fig. 3: Electrical connection for loads in switching mode

- ⓘ Observe the admissible load ratings (cf. 'Technical data').
- ⓘ The device can be used with different phase conductors (L1, L2, L3).
- ⓘ Do not connect three-phase AC motors to the actuator.

Installing / removing the protective cap

To protect the bus lines against hazardous voltages, especially in the area of the connecting terminals, a protective cap can be installed.

The cap is installed with the bus terminal in place and the connected bus line led out at the rear.

- To install the cap: Slide the cap over the bus connecting terminal until it is heard to engage (cf. Fig. 4.A).
- To remove the cap: Remove the cap by pressing the sides slightly and by pulling it out to the front (cf. Fig. 4.B).

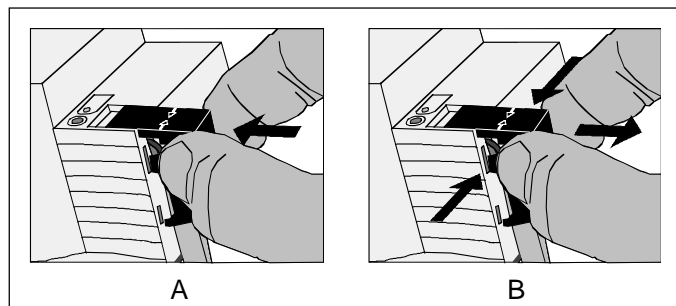

Fig. 4: Installing / removing the protective cap

2.4 Commissioning

After installation of the actuator and connection of the bus line, the mains supply and of all electrical loads, the device can be put into operation. Only the shutter mode requires some special commissioning measures before the device can be programmed with the ETS. The following procedure is generally recommended...

**DANGER!**

Electric shock in case of accidental contact with live parts. Electric shocks can be fatal. Before working on the device, cut out the mains supply and cover up live parts in the surroundings.

Measuring the travelling times (only in shutter mode)

For the purpose of positioning blinds, shutters and awnings or for adjusting the opening angle of venting louvers, the actuator needs accurate information about the maximum travelling time.

Switch on the mains supply.

- If not yet done, move the blind/shutter into the upper end position (open venting louver completely)
The upper limit-stop position is reached (venting louver opened).
- Start the measuring time and move the blind/shutter by manual control into the lower end position (close the venting louver completely).
- Stop the time measurement when the lower limit (when the completely closed) position is reached.
- Enter the measured value in the ETS (cf. software description).

i It is recommended to perform several time measurements and to take the average of these values.

i The travelling time can also be determined after commissioning with the ETS (bus operation).

Measuring the travelling time extension (only in shutter mode)

When travelling upwards, blinds or shutters have a tendency of moving more slowly due to their own weight or to external physical influences (e.g. temperature, wind, etc.). The same applies to venting louvers where opening may take longer than closing.

For this reason, the switching/shutter actuator takes the parameterized travelling time extension into account when moving upwards or when opening the louvers (long-time operation / positioning). The extension is computed as a percentage of the travelling times in both directions.

The blind/shutter (venting louver) must be in the lower end position (venting louver closed). Switch on the mains supply.

- If not yet done, move the blind/shutter into the lower end position (close venting louver completely). Lower end position reached (venting louver closed).
- Start the measuring time and move the blind/shutter by manual control into the upper end position (open the venting louver completely).
- Stop the time measurement when the upper limit (the completely open) position is reached.
- Express the measured value as a percentage of the determined blind/shutter travelling time and enter the value in the ETS (cf. software description).

i It is recommended to perform several time measurements and to take the average of these values.

i The travelling time extension can also be determined after commissioning with the ETS (bus operation).

Measuring the slat moving time (only in shutter mode)

In the case of blinds with slats, the slat moving time is for technical reasons part of the overall travelling time of the blinds/shutters. The slat moving time is the time required for a movement between the slat positions "closed – 100 %" and "open – 0 %". In order to compute the opening angle of the slats, the actuator needs an information about the slat moving time.

In case of blinds with slats, the travelling time of the slats cannot be determined by automatic end position detection. For this reason, the slat moving time must always be measured 'manually'.

The slats must be completely closed (as in case of downward travel of the blind).

Switch on the mains supply.

- Start the measuring time and open the slats completely by manual control (as in case of upward travel of the blind).
- Take the measuring time when the completely open position is reached.
- Enter the measured value in the ETS (cf. software description).

i It is recommended to perform several time measurements and to take the average of these values.

i The slat-moving time can also be determined after commissioning with the ETS (bus operation).

Commissioning with the ETS

- Switch on the bus voltage
Check: the red programming LED must light up when the programming button is being depressed.
 - Download the physical address and the application data with the ETS.
- ❗ When the mains supply is on, the outputs of the actuator can be switched manually even if there is no bus voltage or if the actuator is not yet programmed. Due to this feature, the drives connected to the individual outputs can be checked for proper functioning already during site operation.

Performing a reference travel (optional only in shutter mode)

The switching/shutter actuator can approach predefined blind/shutter or louver positions only if the current positions are known. For this purpose, each output must be given the opportunity to synchronize itself whenever the supply voltage is switched on or after every ETS programming run (physical address, application program). The synchronization is performed by means of the reference travel.

Switch on the mains supply.

- If not yet done, move the blinds/shutters to the upper end position (open venting louver completely).
- Wait until the output relay has switched off (not only the limit switch of the drive).
The reference travel is terminated.

- ❗ The switching/shutter actuator stores the blind/shutter, slat or louver positions temporarily. After each supply voltage failure (failure of the bus voltage and of the mains voltage) or after programming with the ETS, the actuator therefore automatically performs a reference travel for each output before a new position can be approached.
- ❗ After bus voltage return, the switching/shutter actuator generates an "invalid position" message for each output which can also be transmitted to the bus, if so parameterized. The message is cancelled (inverted message value) as soon as a reference travel can be performed. In case of automatic end position detection, a travelling time must have been learnt beforehand.

2.5 Operation

All outputs of the switching/shutter actuator can also be operated manually. The keypad with 4 function keys and 3 status LEDs on the front panel of the device can be used for setting the following modes of operation...

- Bus control mode: operation from touch sensors or other bus devices
- Temporary manual control mode: local manual control with keypad, automatic return to bus operation,
- Permanent manual control mode: local manual control with keypad

- ❗ The operating modes can be enabled or disabled by parameter settings in the ETS.
- ❗ When manual control is active, the outputs cannot be controlled via the bus.
- ❗ Manual control is possible only while the actuator is supplied with power from the mains. The manual control mode ends in case of bus voltage return or mains voltage failure.
- ❗ Manual control in the bus mode can be disabled by a telegram. The manual mode is terminated on activation of the disabling function.
- ❗ Further details concerning the manual mode, especially with respect to the possible parameter settings and the interaction with other functions of the switching/shutter actuator can be found in chapter 4. "Software description" of the present documentation.

Controls and indicators for manual control

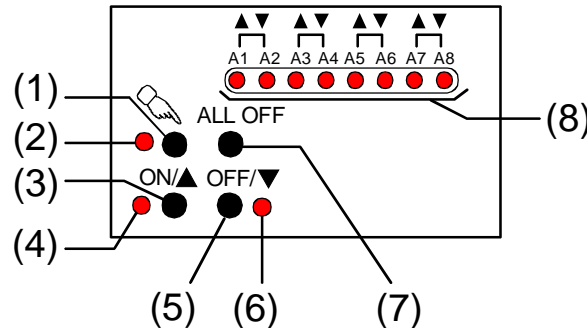

Fig. 5: Controls and indicators for manual control for switching/shutter actuator 4/8fold

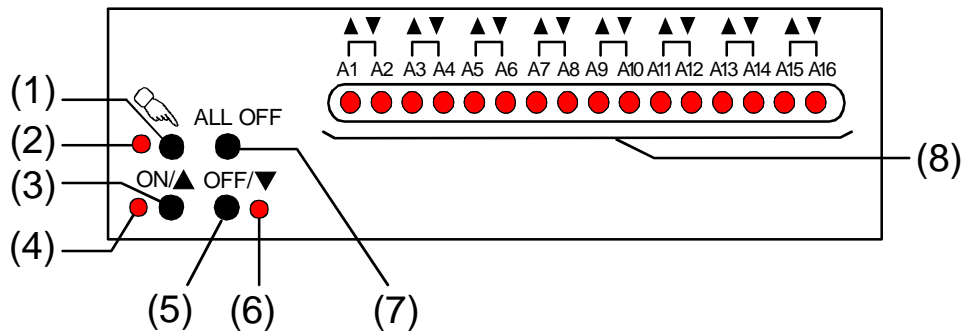

Fig. 6: Controls and indicators for manual control for switching/shutter actuator 8/16fold

- (1) Key Activation / deactivation of manual control
- (2) LED : indicates permanent manual control.
- (3) Key :
 - In shutter mode:
 - Sustained press: upward travel output (long-time operation) / brief press: output stop.
 - In switching mode:
 - Press: output ON.
- (4) Status LED ON/: indicates an active travel movement in the manual mode (up / open) or a closed relay contact.
- (5) Taste OFF/:
 - In shutter mode:
 - Sustained press: downward travel output (long-time operation)/ brief press: output stop.
 - In switching mode:
 - Press: output OFF.
- (6) Status LED OFF/: indicates an active travel movement in the manual mode (down / close) or an opened relay contact. (7)
- (7) Key ALL OFF: stop all drives / all outputs OFF (only in permanent manual control).
- (8) Status LEDs /: when ON, the LEDs indicate active travel movements in the shutter mode or closed relay contacts in the switching mode when controlled via the bus or manually.

Priorities

The switching/shutter actuator distinguishes between different functions that can be active at an output. In order to prevent conflicting output states, each available function has a certain priority. The function with the higher priority overrides the function with the lower priority.

In the shutter mode, the following priorities apply...

- 1st priority: manual control (highest priority),
- 2nd priority: forced position,
- 3rd priority: safety function(s),

Priority levels 4 and 5 can be parameterized in the ETS. The options are then...

- 4th priority: sun protection function
- 5th priority: direct operation via the bus (short-time/long-time operation, positioning, scenes, central function),

or

- 4th priority: direct operation via the bus (short-time/long-time operation, positioning, scenes, central function),
- 5th priority: sun protection function

or

- 4th priority: sun protection function and direct operation via the bus (short-time/long-time operation, positioning, scenes, central function).

In the switching mode, the following priorities apply...

- 1st priority: manual control (highest priority),
- 2nd priority: forced control or disabling function,
- 3rd priority: logic function
- 4th priority: direct operation via the bus (Object "Switching", "Scene", "Central function")

Activating the temporary manual control

Manual control is enabled in the ETS.

- Press the  key briefly (< 1 s).

In shutter mode: The two status LEDs of A1 are flashing (LED  remains off).



In switching mode: The status LED of A1 is flashing (LED  remains off).

 With outputs parameterized for shutter operation in the ETS, the 2 status LEDs of an output combination are always flashing. With outputs parameterized for switching operation, only the status LED of the selected output is flashing. Mixed operation is possible.

 After 5 s without a key-press, the actuator returns automatically to bus operation.



Deactivating temporary manual control

Temporary manual control is active.

- No key-press for 5 s
 - or -
 - select all outputs one after another by a brief press of the  key. Thereafter, press the  key once again.
 - or -
 - switch off the power supply or bus reset (bus voltage return).
Temporary manual control is terminated. The status LEDs A1...A8 / A16 indicate the status for bus operation, when the mains voltage is on.
- i** During a deactivation of the temporary manual control mode, the state selected by manual control does not change. If, however, a function with a priority higher than that of the direct operation (e.g. forced position, disabling function or safety function) has been activated via the bus before or during manual control, the actuator executes the function with the higher priority for the outputs concerned.
- i** Beim Ausschalten des kurzzeitigen Handbetriebs wird der durch die Handbedienung eingestellte



Activating permanent manual control

Manual control is enabled in the ETS. Bus operation or temporary manual control is active.

- Press the  key for at least 5 s.
The  status LED is illuminated.
In shutter mode: The two state indicator LEDs of A1 are flashing.
In switching mode: The state indicator LED of A1 is flashing.
Permanent manual control is now activated:

Deactivating permanent manual control

Permanent manual control active:

- Press the  key for at least 5 s.
 - or -
 - Shut off the power supply or make a bus reset (bus voltage return).
The  status LED goes out. The state indicator LEDs A1...A6 / A16 show the status for bus operation, when the mains voltage is on.
- i** Depending on the parameterization of the actuator in the ETS, the outputs will be set to the state last adjusted in the manual mode or to the state internally tracked (direct operation, forced position / disabling function, safety or sun protection position) when the permanent manual mode is shut off.

Controlling an output manually

Manual control (permanent or temporary) is active.

- Select the desired output: Press the  key briefly (if necessary, repeatedly).
The state indicator LED of the selected output A1...A8 / A16 is flashing. In the shutter mode, the LEDs of an output combination are flashing. In addition, the switching state or a travel movement of the selected output is signalled by the status LED "ON/▲" or "OFF/▼" on the keypad.
- Control the output by pressing the ON/▲ or the OFF/▼ key.
In shutter mode:
Brief press (< 1 s) on the ON/▲ or OFF/▼ key: stopping.
Long press (> 1 s) on the ON/▲ key: upward movement or stopping.
Long press (> 1 s) on the OFF/▼ key: downward movement or closing.
In switching mode:
Pressing the ON/▲ key: switching on (closing the relay contact).
Pressing the OFF/▼ key: switching off (opening the relay contact).
The selected drive motor executes the corresponding commands immediately.

Shutting off all outputs (in shutter mode: stopping all drives)



Permanent manual control is active:

- Press the ALL OFF key.
All outputs are shut off immediately (stop). The outputs are not locked. Individual activation is again possible after shutoff.
-  The "ALL-OFF" function is not available in temporary manual control.

Disabling bus control of individual outputs manually

Permanent manual control is active:

Disabling of the bus control mode must have been enabled in the ETS.

- Select the output: Press the  key briefly (if necessary, repeatedly).
The state indicator LEDs of the selected output A1...A8 / A16 are flashing. In the blind/shutter mode, the LEDs of the output combination are flashing. In addition, the switching state or a travel movement of the selected output is signalled by the status LED "ON/▲" or "OFF/▼" on the keypad.
 - Press the ▲ and the ▼ key simultaneously for at least 5 s.
The concerned output A1...A8 / A16 is locked (control via the bus not possible).
The state indicator LEDs of the selected output A1...A8 / A16 are flashing fast.
-  To unlock, proceed in the same way.
-  An output that has been disabled manually can thereafter only be operated in the permanent manual mode.

3 Technical data

Mark of approval:	KNX / EIB / VDE
Ambient temperature:	-5 °C ... +45 °C
Storage / transport temperature:	-25 °C ... +70 °C (Storage above + 45 °C reduces the lifetime)
Mounting position:	any position (preferred: output terminals at the top)
Minimum distances:	none
Type of fastening:	Snap-fastening on DIN rail in closed cabinets (e.g. small distributions, etc.) / KNX / EIB data rail not required.
KNX / EIB supply	
Voltage:	21 ... 32 V DC SELV
Power consumption:	typ. 150 mW
Connection:	standard KNX/EIB bus connection terminal
External supply	
Voltage:	230 ... 240 V AC $\pm 10\%$, 50/60 Hz
Connection:	with screw terminals: 0.5...4 mm ² solid and stranded wire without ferrule 0,5...2,5mm ² stranded wire with ferrule Max. tightening torque: 0.8 Nm
Total power loss:	switching/shutter actuator 4/8fold: max. 3 W switching/shutter actuator 8/16fold: max. 4,5 W
Response to bus voltage failure:	depending on parameterization (cf. "Parameter description")
Response to mains voltage failure:	outputs are shut off (stop)
Response to bus / mains voltage return:	depending on parameterization (cf. "Parameter description")

Technical data (continued)

Output:

Number: switching/shutter actuator 4/8fold:
max. 8 switching outputs / max. 4 shutter outputs
switching/shutter actuator 8/16fold:
max. 16 switching outputs / max. 8 shutter outputs
Depending on parameterized mode of operation. Mixed operation is possible.

Connection: with screw terminals:
0.5...4 mm² solid and stranded wire without ferrule
0.5...2.5 mm² stranded wire with ferrule
Max. tightening torque: 0.8 Nm

Type of contact: potential-free μ -contact, monostable
(In the shutter mode, the travel directions of an output are interlocked by the software of the actuator.)

Switching voltage: 230 ... 240 V AC $\pm 10\%$, 50/60 Hz

Switching capacity 230 V AC
16 A / AC 1
10 A / AC 3
16 AX

Max. inrush current: 800 A, 200 μ s
165 A, 20 ms

Min. switching current: 100 mA

Overall load current rating of the actuator:
switching/shutter actuator 4/8fold: max. 80 A
switching/shutter actuator 8/16fold: max. 160 A

Overall load current rating of neighbouring outputs:
max. 20 A

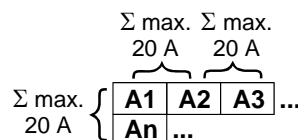

Technical data (continued)

Output:

Switching capacity:

Resistive load	3000 W
Capacitive load:	16 A, max. 140 µF
Motor load (blind / shutter or fan motors):	1380 VA

Lamp loads:

Incandescent lamps:	3000 W
HV halogen:	2500 W
LV halogen:	
conventional transformers:	1200 VA
Tronic transformers:	1500 W

Fluorescent lamps T5 / T8

non-compensated	1000 W
parallel compensated:	1160 W, 140 µF
Lead-lag circuit:	2300 W, 140 µF

Compact fluorescent lamps:

non-compensated:	1000 W
parallel compensated:	1160 W, 140 µF

Mercury vapour lamps:

non-compensated:	1000 W
parallel compensated:	1160 W, 140 µF

ELECTRONIC BALLASTS:

The number of electronic ballasts that can be connected to the device depends on type and make of the ballast and additionally also on the condition of the low-voltage mains supply network. For this reason, different electronic ballasts are listed below as an example (manufacturer: Osram).

Max. number per output (25.000 switching cycles):

T8 lamps:	
QTP 2 x 58 W	11
T5 lamps:	
QT-FH 4 x 14 W	10
QT-FQ 2 x 54 W	11

4 Software information

4.1 Software specifications

ETS search paths: - Output / Binary output mix / Switch / shutter actuator 16/8gang 16A RMD
 - Output / Binary output mix / Switch / shutter actuator 8/4gang 16A RMD
 BAU used: TPUART + μ C
 KNX/EIB type class: 3b - device with cert. PhL + stack
 Configuration: S-mode standard
 PEI type: "00"_{Hex} / "0"_{Dez}
 PEI connector: no connector

Applications for switching/shutter actuator 4/8fold:

No.	Summarized description:	Name	Version:	Executable from mask version:
1	Multi-function switching/shutter application. Features for each output in the shutter mode: separately parameterizable travelling times, enlarged feedback functions, assignments to up to 5 different safety functions and a sun protection function adapted to the highest requirements. Integration into scenes or forced positions also available (only for ETS3.0d and onwards). Centralized control of all outputs is also possible. Features for each output in the switching mode: timing functions, logic operations, scenes (only for ETS3.0d and onwards), disabling functions, operating hours counter, current measurement, cyclical monitoring and an enlarged set of response telegrams. Centralized switching of all outputs is also available. Moreover, the preferred states of the relays in case of bus voltage failure or bus / mains voltage return and after ETS programming can be preset separately.	Switching, shutter 208002	0.1 for ETS 2 and ETS 3a...c	705
		Switching, shutter 208012	1.1 for ETS3 from version d onwards	

Applications for switching/shutter actuator 8/16fold:

No.	Summarized description:	Name	Version:	Executable from mask version:
1	<p>Multi-function switching/shutter application. Features for each output in the shutter mode: separately parameterizable travelling times, enlarged feedback functions, assignments to up to 5 different safety functions and a sun protection function adapted to the highest requirements. Integration into scenes or forced positions also available (only for ETS3.0d and onwards). Centralized control of all outputs is also possible.</p> <p>Features for each output in the switching mode: timing functions, logic operations, scenes (only for ETS3.0d and onwards), disabling functions, operating hours counter, current measurement, cyclical monitoring and an enlarged set of response telegrams. Centralized switching of all outputs is also available.</p> <p>Moreover, the preferred states of the relays in case of bus voltage failure or bus / mains voltage return and after ETS programming can be preset separately.</p>	<p>Switching, shutter 207802</p> <p>Switching, shutter 207812</p>	<p>0.1 for ETS 2 and ETS 3a...c</p> <p>1.1 for ETS3 from version d onwards</p>	705

4.2 Software "Switching, shutter 2078x2 / 2080x2"

4.2.1 Scope of functions

General:

- Outputs can be parameterized for shutter or switching operation. In the böblind/shutter mode, two neighbouring outputs are combined into a shutter output. Mixed operation in an actuator is possible.
- Behaviour in case of bus voltage failure and bus voltage return as well as after ETS programming presettable for each output.
- Active feedback telegrams can be globally delayed after bus voltage return.
- Manual control of outputs independent of the bus (for instance, site operation) with LED state indicators.
- Each output offers the full scope of functions without any restrictions. All channel-oriented functions can be parameterized separately for each output. This feature permits independent and multi-functional control of the switching or shutter outputs.

Shutter mode:

- Mode of operation parameterizable: control of blinds with slats, shutters or venting louvers.
- Separately parameterizable blind/shutter travelling times with travelling time extension for moves into the upper end position.
- For blinds with slats, a slat-moving time can be independently parameterized.
- Travel direction change-over time and the times for short-time and long-time operation presettable.
- Central control of all shutter outputs via 1-bit long-time operation telegram possible.
- Blind/shutter or slat position feedback telegram (only with bus control). In addition, an invalid blind/shutter position or an invalid travel movement can be reported back. Active (transmitting after changes) or passive (object readout) feedback functions.
- Assigning of outputs to up to 5 different safety functions (3 wind alarms, 1 rain alarm, 1 frost alarm) optionally with cyclical monitoring. The safety functions (objects, cycle times, priority) are programmed device-oriented and in common for all outputs. The assignment of individual outputs to the safety functions and the safety measures can be parameterized for each channel.
- An extensive sun protection function with fixed and variable blind/shutter or slat positions at the beginning and at the end of the function can be activated separately for each output. Dynamic slat offset for slatted blinds included.
- Forced-position function can be implemented for each shutter output (only for ETS3.0d).
- Integration into light-scenes possible: up to 8 internal scenes parameterizable per output (only for ETS3.0d).

Switching mode:

- Bus-independent manual switching of relays / switching position indication.
- Operation as break or make contacts.
- Central switching function with centralized feedback.
- Switching feedback mode (only with bus operation): active (after changes or cyclical transmission to the bus) or passive (object readout function) feedback function.
- Logische Verknüpfungsfunktion für jeden Ausgang.
- Logic function individual for each output.
- Disabling function parameterizable for each channel. Forced-control position (only for ETS3.0d) function separately for each output as an alternative.
- Timer functions (on-delay, off-delay, staircase lighting timer – optional with pre-warn function).
- Integration into light-scenes possible: up to 8 internal scenes parameterizable per output (only for ETS3.0d).

4.2.2 Software information

ETS project design and commissioning

For project design and commissioning of this device it is recommended to use the ETS3.0d. Advantages with regard to downloading (significantly shorter loading times) and parameter programming can be expected only if this ETS patch version or later versions are used. The advantages consist in the use of the new mask version 7.5 and the parameter presentation of the ETS3.

The product database required for the ETS3.0d is offered in the *.VD4 format. The corresponding application program has version number "1.1". For the ETS2 and older versions of the ETS3 a separate product database in the *.VD2 format is available. The application program for these ETS versions is version number "0.1".

With regard to the scope of functions described in the present documentation the two application programs are different! In the application program with version number "0.1", the scene function or the forced-control positions are not available.

When older ETS versions are updated to the level of version ETS3.0d or to that of later versions, an additional tool in the form of an ETS add-in is available. This tool is capable of converting older product databases of application version "0.1", for instance from existing ETS2 projects, into the new application format (version "1.1"). This feature permits making use of the advantages of the ETS3.0d application in an easy way and without any changes. The ETS3 add-in can be obtained separately from the manufacturer and is free of charge.

Safe-state mode

If the device - for instance as a result of errors in the project design or during commissioning - does not work properly, the execution of the loaded application program can be halted by activating the safe-state mode. The safe-state mode does not permit controlling the outputs via the bus and by hand. The actuator remains passive since the application program is not being executed (state-of-execution: terminated). Only the system software is still functional so that the ETS diagnosis functions and also programming of the device continue to be possible.

Activating the safe-state mode

- Shut off the bus and the mains voltage supply.
- Press the programming button and keep it pressed.
- Switch on the bus or mains voltage. Release the programming button only after the programming LED starts blinking slowly.

The safe-state mode is activated. With a new brief press on the programming button, the programming mode can be switched on and off as usual also in the safe-state mode. The programming LED will nevertheless continue to blink independently of the programming mode as long as the safe-state mode is active.

i The safe-state mode can be terminated by switching off the supply voltage (bus or mains) or by programming with the ETS.

Unloading the application program

The application program can be unloaded with the ETS. In this case, manual control as part of the application program is not available either.

4.2.3 Object table

Number of communication objects: 4/8fold: 74 (max. object number 109 – gaps in between)
8/16fold: 138 (max. object number 213 – gaps in between)



Number of addresses (max): 254

Number of assignments (max): 255

Dynamic table management: no

Maximum table length: 255

Channel-independent objects:

Function: Manual control					
Object	Function	Name	Type	DP type	Flag
 0	Disabling	Manual control	1 bit	1.003	C, W, -, (R) ¹
Description: 1-bit object for disabling the keys for manual control on the device. The polarity can be parameterized.					
Function: Manual control					
Object	Function	Name	Type	DP type	Flag
 1	Status	Manual control	1 bit	1.002	C, -, T, (R) ¹
Description: 1-bit object for manual control status transmission The object is "0", when manual control is deactivated (bus control). The object is "1", when manual control is being activated. The user can parameterize whether the temporary or the permanent manual control will be indicated as status information or not.					
Function: Shutter central function (in shutter mode)					
Object	Function	Name	Type	DP type	Flag
 2	Central travel control	All shutter outputs	1 bit	1.008	C, W, - (R) ¹
Description: 1-bit object for central actuation (long-time travel) of assigned shutter outputs. The polarity can be parameterized.					

¹ Each communication object can be read out. For reading, the R-flag must be set.

Channel-independent objects (continued):

Function: Safety function (in shutter mode)					
Object	Function	Name	Type	DP type	Flag
 3	Wind alarm 1	Safety	1 bit	1.005	C, W, -, (R) ¹
Description: 1-bit object for central activation or deactivation of the first wind alarm ("0" = wind alarm deactivated / "1" = wind alarm activated).					

Function: Safety function (in shutter mode)					
Object	Function	Name	Type	DP type	Flag
 4	Wind alarm 2	Safety	1 bit	1.005	C, W, -, (R) ¹
Description: 1-bit object for central activation or deactivation of the second wind alarm ("0" = wind alarm deactivated / "1" = wind alarm activated).					

Function: Safety function (in shutter mode)					
Object	Function	Name	Type	DP type	Flag
 5	Wind alarm 3	Safety	1 bit	1.005	C, W, -, (R) ¹
Description: 1-bit object for central activation or deactivation of the third wind alarm ("0" = wind alarm deactivated / "1" = wind alarm activated).					

Function: Safety function (in shutter mode)					
Object	Function	Name	Type	DP type	Flag
 6	Rain alarm	Blind safety	1 bit	1.005	C, W, -, (R) ¹
Description: 1-bit object for central activation or deactivation of the rain alarm ("0" = rain alarm deactivated / "1" = rain alarm activated).					

Function: Safety function (in shutter mode)					
Object	Function	Name	Type	DP type	Flag
 7	Frost alarm	Safety	1 bit	1.005	C, W, -, (R) ¹
Description: 1-bit object for central activation or deactivation of the rain alarm ("0" = rain alarm deactivated / "1" = rain alarm activated).					

¹ Each communication object can be read out. For reading, the R-flag must be set.

Channel-independent objects (continued):







Function:	Central function (in switching mode)				
Object	Function	Name	Type	DP type	Flag
 8	Central switching function	All switching outputs	1 bit	1.001	C, W, -, (R) ¹
Description:	1-bit object for central switching of switching outputs assigned. The polarity can be parameterized.				

Function:	Centralized feedback (in switching mode)				
Object	Function	Name	Type	DP type	Flag
 9	Centralized feedback	All switching outputs	4 bytes	27.001	C, -, T, R ²
Description:	4-byte object for centralized feedback of all of the actuators switching states.				

¹ Every communication object can be read out. For readout, the R-flag must be set.

² Depending on parameterization, feedback objects are either actively transmitting (T-flag set) or passively readable (R-flag set).

Channel-oriented objects for switching mode:

Function: Output switching (in switching mode)					
Object	Function	Name	Type	DP type	Flag
 10, 23, ... , 205 ³	Switching	Output 1 – 16 ³	1 bit	1.001	C, W, -, (R) ¹
Description: 1-bit object for controlling one output ("1" = on / "0" = off; observe the parameterized operating mode!).					
Function: Forced-control position (in switching mode - only for ETS3.0d and onwards)					
Object	Function	Name	Type	DP type	Flag
 11, 24, ... , 206 ³	Forced-control position	Output 1 – 16 ³	2 bit	2.001	C, W, -, (R) ¹
Description: 2-bit object for forced control of an output. The object state after bus voltage return can be predefined by parameters.					
Function: Disabling function (in switching mode)					
Object	Function	Name	Type	DP type	Flag
 12, 25, ... , 207 ³	Disabling	Output 1 – 16 ³	1 bit	1.003	C,W, -, (R) ¹
Description: 1-bit object for disabling of an output (polarity parameterizable).					
Function: Logic operation (in switching mode)					
Object	Function	Name	Type	DP type	Flag
 13, 26, ... , 208 ³	Logic operation	Output 1 – 16 ³	1 bit	1.002	C, W, -, (R) ¹
Description: 1-bit object for the input of the logic operation of an output. The object value after bus voltage return or after programming with the ETS can be predefined with parameters.					
Function: Staircase function					
Object	Function	Name	Type	DP type	Flag
 14, 27, ... , 209 ³	Staircase function start/stop	Output 1 – 16 ³	1 Bit	1.010	C,W, -, (R) ¹
Description: 1-bit object for activation or deactivation of the time delay of the staircase function of an output ("1" = on / "0" = off).					
Function: Scene function (in switching mode - only for ETS3.0d and onwards)					
Object	Function	Name	Type	DP type	Flag
 16, 29, ... , 211 ³	Scene extension	Output 1 – 16 ³	1 byte	18.001	C,W, -, (R) ¹
Description: 1-byte object for recalling scenes or for storing new scene values.					

³ The number of outputs of the communication objects depends on the programmed device.

¹ Every communication object can be read out. For readout, the R-flag must be set.

Channel-oriented objects for switching mode (continued):

Function: Switching status feedback (in switching mode)						
Object	Function	Name	Type	DP type	Flag	
 18, 31, ..., 213 ³	Switching feedback	Output 1 – 16 ³	1 bit	1.001	C, -, T, R ²	
Description: 1-bit object for feedback signalling of the switching state of an output ("1" = on / "0" = off; observe the parameterized mode of operation!)						

Channel-oriented objects for shutter mode:

Function: Long-time operation (in shutter mode)						
Object	Function	Name	Type	DP type	Flag	
 10, 36, ..., 192 ⁴	Long-time operation	Output 1/2 – 15/16 ⁴	1 bit	1.008	C, W, -, (R) ¹	
Description: 1-bit object for activation of the long-time operation						

Function: Short-time operation (in shutter mode)						
Object	Function	Name	Type	DP type	Flag	
 11, 37, ..., 193 ⁴	Short-time operation	Output 1/2 – 15/16 ⁴	1 bit	1.007	C, W, -, (R) ¹	
Description: 1-bit object for activation of the short-time operation or for stopping of a travel movement.						

Function: Forced position (in shutter mode - only for ETS3.0d and onwards)						
Object	Function	Name	Type	DP type	Flag	
 12, 38, ..., 194 ⁴	Forced position	Output 1/2 – 15/16 ⁴	2 bit	2.008	C, W, -, (R) ¹	
Description: 2-bit object for forced control of an output. The object state after bus voltage return can be predefined by means of a parameter.						

Function: Scene function (in shutter mode - only for ETS3.0d and onwards)						
Object	Function	Name	Type	DP type	Flag	
 13, 39, ..., 195 ⁴	Scene extension	Output 1/2 – 15/16 ⁴	1 byte	18.001	C, W, -, (R) ¹	
Description: 1-byte object for recalling scenes or for storing new scene values.						





³ The number of outputs of the communication objects depends on the programmed device.

² Depending on parameterization, feedback objects are either actively transmitting (T-flag set) or passively readable (R-flag set).

⁴ The object designations are independent of the selected channel definition.

¹ Every communication object can be read out. For readout, the R-flag must be set.

Channel-oriented objects for shutter mode (continued):





Function:	Sun protection function (in shutter mode)					
Object	Function	Name	Type	DP type	Flag	
 18, 44, ... , 200 ⁴	Sunshine / shading facade	Output 1/2 – 15/16 ⁴	1 bit	1.002	C, W, -, (R) ¹	
Description:	1-bit object for activation or deactivation of sun shading in the simple or enlarged sun protection mode (sun / no sun). The polarity can be parameterized.					
Function:	Sun protection function (in shutter mode)					
Object	Function	Name	Type	DP type	Flag	
 19, 45, ... , 201 ⁴	Sunsh./shading position ⁵	Output 1/2 – 15/16 ⁴	1 byte	5.001	C, W, -, (R) ¹	
Description:	1-byte object for presetting a variable position value (0...255) for the height of the blind/shutter curtain or the venting louver position when the sun protection is active.					
Function:	Sun protection function (in shutter mode)					
Object	Function	Name	Type	DP type	Flag	
 20, 46, ... , 202 ⁴	Sunsh./shading slat position	Output 1/2 – 15/16 ⁴	1 byte	5.001	C, W, -, (R) ¹	
Description:	1-byte object for presetting a variable slat position value (0...255) when the sun protection is active.					
Function:	Sun protection function (in shutter mode)					
Object	Function	Name	Type	DP type	Flag	
 21, 47, ... , 203 ⁴	Sunshine slat position offset	Output 1/2 – 15/16 ⁴	1 byte	6.001	C, W, -, (R) ¹	
Description:	1-byte object for presetting a slat position angle (- 100 % ... +100 % / smaller or larger position angles are treated as + or – 100 %) for 'manual' readjustment of the slat position during active sun protection.					

⁴ The object designations are independent of the selected channel definition.

¹ Each communication object can be read out. For reading, the R-flag must be set.

⁵ The object designation varies with the type of curtain (blind, shutter / awning, venting louver).

Channel-oriented objects for shutter mode (continued):

Function: Position feedback (in shutter mode)						
Object	Function	Name	Type	DP type	Flag	
 23, 49, ... , 205 ⁴	Position feedback ⁵	Output 1/2 – 15/16 ⁴	1 byte	5.001	C, -, T, R ²	
Description: 1-byte object for position feedback of the blind/shutter curtain height or louver position (0...255)						
Function: Position feedback (in shutter mode)						
Object	Function	Name	Type	DP type	Flag	
 24, 50, ... , 206 ⁴	Slat position feedback	Output 1/2 – 15/16 ⁴	1 byte	5.001	C, -, T, R ²	
Description: 1-byte object for position feedback of the slat position (0...255).						
Function: Position feedback (in shutter mode)						
Object	Function	Name	Type	DP type	Flag	
 26, 52, ... , 208 ⁴	Invalid position feedback	Output 1/2 – 15/16 ⁴	1 bit	1.002	C, -, T, R ²	
Description: 1-bit object for reporting back an invalid position of the blind/shutter curtain height or louver position ("0" = position valid / "1" = position invalid).						
Function: Travel movement feedback (in shutter mode)						
Object	Function	Name	Type	DP type	Flag	
 27, 53, ... , 209 ⁴	Travel movement feedback	Output 1/2 – 15/16 ⁴	1 bit	1.002	C, -, T, R ²	
Description: 1-bit object for active travel movement feedback (output active - up or down). ("0" = no travel movement / "1" = travel movement)						

⁵ The object designation varies with the type of curtain (blind, shutter / awning, venting louver).

⁴ The object designations are independent of the selected channel definition.

² Depending on parameterization, feedback objects are either actively transmitting (T-flag set) or passively readable (R-flag set).

Channel-oriented objects for shutter mode (continued):

Function:	Position preset				
Object	Function	Name	Type	DP type	Flag
 28, 54, ... , 210 ⁴	Position ⁵	Output 1/2 – 15/16 ⁴	1 byte	5.001	C, W, – (R) ¹
Description:	1-byte object for presetting a position value (0...255) for the height of the blind/shutter curtain or the venting louver position in direct operation.				

Function:	Position preset				
Object	Function	Name	Type	DP type	Flag
 29, 55, ... , 211 ⁴	Slat position	Output 1/2 – 15/16 ⁴	1 byte	5.001	C, W, – (R) ¹
Description:	1-byte object for presetting a slat position value (0...255) in direct operation.				

⁵ The object designation varies with the type of curtain (blind, shutter / awning, venting louver).

⁴ The object designations are independent of the selected channel definition.

¹ Each communication object can be read out. For reading, the R-flag must be set.

4.2.4 Functional description

4.2.4.1 Description of channel-independent functions

Delay after bus voltage return

To reduce telegram traffic on the bus line after bus voltage activation (bus reset), after connection of the device to the bus line or after programming with the ETS, it is possible to delay all actively transmitted feedback telegrams of the actuator. For this purpose, a channel-independent delay can be specified (parameter "Delay after bus voltage return" on parameter page "General"). Feedback telegrams for bus initialization will therefore be transmitted to the bus only after the parametrized time has elapsed.

Which of the feedback telegrams is actually delayed and which is not can be specified for each output channel and for each feedback function separately.

- ❗ The delay has no effect on the behaviour of the outputs. Only the feedback telegrams are delayed. The outputs can also be activated during the delay after bus voltage return.
- ❗ A setting of "0" for the delay after bus voltage return deactivates the delaying function altogether. In this case, all feedback telegrams, if actively transmitted, will be transmitted to the bus without any delay.
- ❗ After switching on of the mains voltage (bus voltage being on at this time), feedback telegrams are always transmitted without delay.

Central function for outputs in switching mode

The actuator offers the possibility of linking selected individual or all output channels in switching mode with a 1-bit central communication object. The behaviour in case of activating an output via the central function is comparable to a central group address linked with all "Switching" objects.

The outputs assigned to the central function are activated in accordance with the central object value received. The polarity of the central telegram can, if necessary, be inverted by means of a parameter.

The behaviour of the channels is identical with 'normal' activation via the "Switching" objects (same priority – last switching command is executed – cf. Fig. 7). In this way, all 'secondary' functions such as timing or supplementary functions or logic operations are included as well. The parameterized relay operation is also evaluated for each output separately.

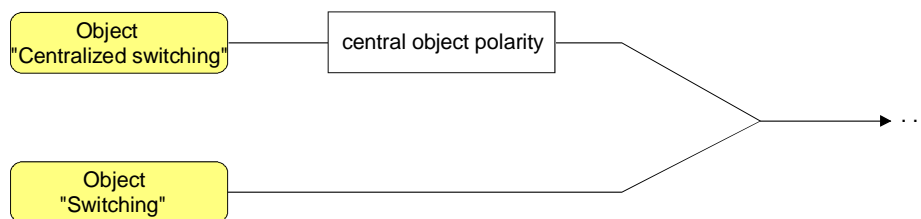

Fig.7: Functional diagram "Centralized switching"

Enabling the central function

- Enable the central function on parameter page "General" by setting the "Central function for outputs in switching mode ?" parameter to "Yes".

When the function is activated, the "Centralized switching" communication object is visible.

Assigning outputs to the central function

Each switching output can be assigned independently to the central function.

The central function must have been enabled on parameter page "General". The assignment has otherwise no effect on the switching output.

- Set the "Assignment to central function" parameter on the "Ax-General" page (x = number of output) to "Yes".

The corresponding output is now assigned to the central function. It can be switched on or off from a central control station.

- ❗ The switching state set by the central function is tracked in the feedback objects and also transmitted to the bus, if they are actively transmitting. The switching state set by a central function is not tracked in the "Switching" objects.
- ❗ After a bus voltage return or after programming with the ETS, the central function is always inactive (object value "0").

Central function for outputs in shutter mode

The actuator offers the possibility of linking selected individual or all output channels with a 1-bit central communication object. The behaviour in case of activating an output via the central function is comparable to a central group address linked with all "Long-time operation" objects.

The outputs assigned to the central function are activated in accordance with the central object value received. The polarity of the central telegram can, if necessary, be inverted by means of a parameter. The behaviour of the channels is identical with the 'normal' activation via the "Long-time operation" objects (same priority – last command is executed – cf. Fig. 8).

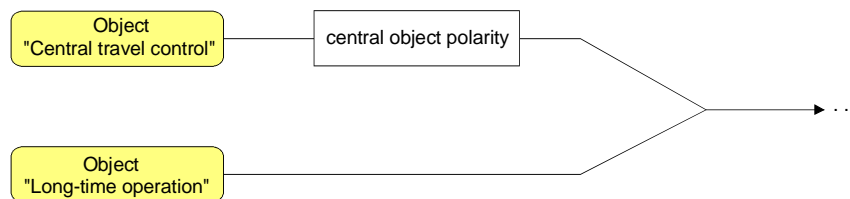

Fig. 8: Function diagram "Central travel control"

Enabling the central function

- Enable the central function on parameter page "General" by setting the "Central function for outputs in shutter mode ?" parameter to "Yes".

When the function is activated, the "Central travel control" communication object is visible.

Assigning outputs to the central function

Each shutter output can be assigned independently to the central function.

The central function must have been enabled on parameter page "General" The assignment has otherwise no effect on the shutter output.

- Set the "Assignment to central function" parameter on parameter page "Ax–Enabled functions" (x = number of output) to "Yes".

The corresponding output is now assigned to the central function and can be controlled centrally.

- ❗ The blind/shutter, louver or slat position newly set by the central function is tracked at the end of a travel movement in the feedback objects and also transmitted to the bus, if these are actively transmitting. It should be noted that the shutter actuator can compute positions after application of the supply voltage only if a reference movement into the upper limit positions has been performed beforehand.
- ❗ The central function belongs to the set of 'direct operations' of an output. For this reason, the central function has the same priority as an operation via short-time or long-time objects, as the control via the positioning objects or as a scene recall.
- ❗ After a bus voltage return or after programming with the ETS, the central function is always inactive (object value "0").

Centralized feedback for outputs in switching mode

After central commands or after bus voltage return, a bus line is generally heavily loaded by data traffic as many bus devices are transmitting the state of their communication objects by means of feedback telegrams. This effect is particularly remarkable when visualizations are used. To keep the telegram load low during a 'bus initialization', the centralized feedback function of the actuator can be employed. The centralized feedback function groups the switching states of all outputs in switching mode together in only one telegram. The 32-bit wide communication object "Centralized feedback" contains the feedback information of the individual outputs in a bit-oriented format and is organized as shown Fig. 9.

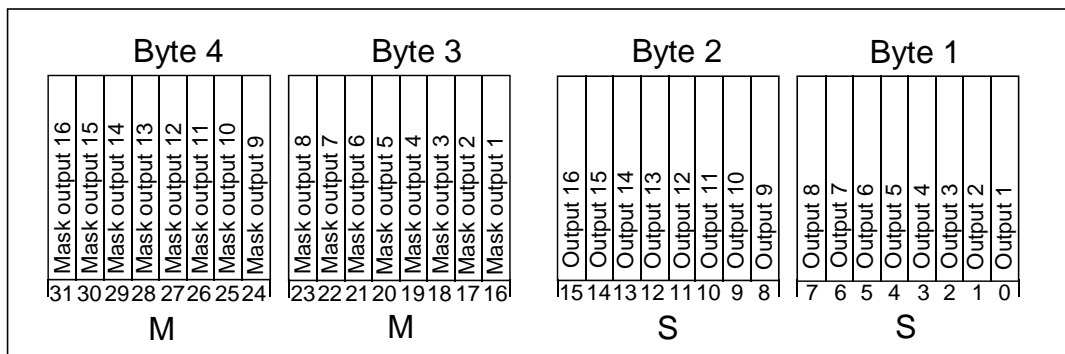

Fig. 9: Structure of the centralized feedback object

The object permits representing up to 16 outputs and thus up to 16 different switching states in a logical format, with each output having one bit representing the switching state ("S" bit) and another one defining the masking ("M" bit). The "S" bits correspond to the logical non-inverted switching states of the outputs and are either "1" (on) or "0" (off). The "M" bits are "1", if there is such an output on the actuator. Likewise, the "M" bits are "0", if there is no corresponding output on the actuator. In the latter case, the pertaining "S" bits are permanently "0" because there is no switching state.

This results in the following object value formats if, for instance, all outputs are set to switching operation ...

Object value format for switching/shutter actuator 4/8fold: "00 FF 00 xx", xx = switching states,

Object value format for switching/shutter actuator 8/16fold: "FF FF xx xx", xx xx = switching states.

The datapoint type of the centralized feedback is KNX-standardized (DPT 27.001). It could be used in suitable visualization applications, for instance in public buildings like schools or hospitals, where the switching states of all actuators are displayed centrally and not separately at the local control units. In such applications, the centralized feedback can replace the 1-bit single feedback and thus reduce the bus load significantly.

Activating the centralized feedback function

The centralized feedback can be used as an active message object or as a passive status object. As an active message object, the centralized feedback information is transmitted to the bus whenever a switching state changes. On the other hand, no telegram will be transmitted when it is used as a passive status object. In this case, the object value must be read out. The ETS automatically sets the object communication flags required for proper functioning.

- The parameter "Make use of centralized feedback ?" of the required function must be set to "Yes, active message object" or "Yes, passive status object".

The 4-byte communication object "Centralized feedback" is enabled. The object can be used when it has been linked with a group address.

Activating centralized feedback on bus voltage return or after ETS programming

The centralized feedback state is transmitted to the bus after bus voltage return or ETS programming if used as active message object. In this case, the feedback can be delayed with the delay being set globally for all outputs together (cf. "Delay after bus voltage return").

- Set the parameter "Time delay for feedback telegram after bus voltage return" of the centralized feedback to "Yes".

The centralized feedback is transmitted with a delay after bus voltage return or ETS programming. No feedback telegram is transmitted during a running delay, even if a switching state changes during this delay.

- Set the parameter "Time delay for feedback telegram after bus voltage return" of the centralized feedback to "No".

The feedback telegram is transmitted immediately after bus voltage return or ETS programming.

Activating cyclical transmission for centralized feedback telegrams

By means of the actively transmitting signalling object, the centralized feedback telegram can – besides being sent in case of state changes – also be transmitted cyclically.

- Set the parameter "Cyclical transmission of centralized feedback telegram ?" on parameter page "General" to "Yes".

Cyclical transmission is now activated.

- Set the parameter "Cyclical transmission of centralized feedback telegram ?" on parameter page "General" to "No".

Cyclical transmission is deactivated so that the centralized feedback is transmitted to the bus only when one of the switching states changes.

- ❶ The cycle time is defined centrally for all cyclical feedback telegrams on the parameter page "Switching outputs time settings".
- ❶ No centralized feedback telegram is transmitted during an active delay after bus voltage return, even if a switching state changes during the delay.
- ❶ A blinking' output' (cf. "disabling function") will always be reported back as "switched on".

Manual control

All outputs of the switching/shutter actuator can also be operated manually. The keypad with 4 function keys and 3 status LEDs on the front panel of the device can be used for setting the following modes of operation...

- bus control: operation from touch sensors or other bus devices
- Temporary manual control: manual control locally with keypad, automatic return to bus control,
- Permanent manual control: local manual control with keypad

The operation of the function keys, the control of the outputs and the status indication are described in detail in chapter "2.5. Manual control".

The following paragraphs are to give a more detailed description of the parameterization, status feedback, disabling via bus control and the interactions with other functions of the shutter actuator when the manual control mode is activated and deactivated.

Manual control is possible only while the actuator is supplied with power from the mains. The actuator is delivered with the manual control mode fully enabled. In this unprogrammed state, the individual outputs can be switched on and off also without bus voltage so that fast function checking of the connected drives (e.g. on the construction site) is possible.

After the first commissioning of the actuator with the ETS, the manual control mode can be separately enabled or disabled for different states of operation. Manual control can, for instance, be disabled during bus operation (bus voltage applied). Another option consists in the complete disabling of the manual control only in case of bus voltage failure. Manual control can therefore be completely disabled during bus operation, but also in case of bus failures only.

Enabling the manual control mode

Manual control for the different states of operation is enabled or disabled by means of the parameters "Manual control in case of bus voltage failure" and "Manual control during bus operation".

- Set the parameter "Manual control in case of bus voltage failure" to "enabled".
Manual control is then basically enabled when the bus voltage is off. This setting corresponds to the setting of the actuator as delivered.
- Set the parameter "Manual control in case of bus voltage failure" to "disabled".
Manual control is completely disabled when the bus voltage is off. In this case, bus operation is not possible either so that the outputs of the actuator can no longer be actuated.
- Set the parameter "Manual control during bus operation" to "enabled".
Manual control is then basically enabled when the bus voltage is on. The outputs of the actuator can be operated via the bus or manually. This setting corresponds to the setting of the actuator as delivered.
- Set the parameter "Manual control during bus operation" to "disabled".
Manual control is completely disabled when the bus voltage is on. In this configuration, the actuator outputs can only be operated via the bus.

i Further parameters and communication objects of the manual control are visible only in the configuration "Manual control during bus operation = enabled". For this reason, the disabling function, the status message and bus control disabling can only be configured in the above parameter setting.

Presetting the behaviour at the beginning and at the end of manual control.

Manual control is divided into temporary and permanent manual control. Depending on these modes, the actuator behaves differently, especially at the end of the control mode. It should be noted that the operation via the bus, i.e. control of the outputs by direct operation (switching / move / step / position / scene / central) or by the sun protection and safety-, disabling- or forced control-functions is always disabled when the manual control is active. This means that the manual control mode has the highest priority.

Behaviour at the beginning of manual control:

There is no difference between temporary or permanent manual control as far as the behaviour at the beginning of manual control is concerned. When manual control is activated, all travel movements that were started beforehand by bus control will still be completed unless the travel movement in question is stopped by hand.

An active forced-position, disabling, safety and sun protection function can be overridden by manual control. These functions are reactivated after deactivation of the manual mode unless they have been cancelled in the meantime.

Behaviour at the end of the manual control:

The behaviour at the end of manual control differentiates between temporary and permanent manual control.

The temporary manual mode is shut off automatically when the last output has been addressed and when the select key  is pressed once more. During a shutoff of the temporary manual control mode, the actuator goes back to 'normal' bus operation and does not change the state selected by manual control. If, however, a forced position, a disabling function, safety or sun protection function (independent of priority) has been activated via the bus before or during manual control, the actuator executes these functions of a higher priority again for the outputs concerned.

The permanent manual control mode is shut off, when the select key  is pressed for more than 5 s. Depending on the parameterization of the actuator in the ETS, the outputs will be set to the state last adjusted in the manual mode or to the state internally tracked (direct operation, forced position, disabling function, safety or sun protection position) when the permanent manual mode is shut off. The parameter "Behaviour at the end of permanent manual control during bus operation" defines the corresponding reaction.

- Set the parameter "Behaviour at the end of permanent manual control during bus operation" to "no change".

All telegrams received during an active permanent manual control mode for direct operation (switching, long-time/short-time, positioning, central, scenes) will be rejected. After the end of the permanent manual control mode, the current state of all outputs remains unchanged. If, however, a forced position, a disabling function, safety or sun protection function (independent of priority) has been activated via the bus before or during manual control, the actuator re-executes these functions of a higher priority for the outputs concerned.

- Set the parameter "Behaviour at the end of permanent manual control during bus operation" to "track outputs".
During an active permanent manual control all incoming telegrams (short-time telegrams – step/stop excepted) are internally tracked. At the end of the manual control mode, the outputs will be set to the tracked states or to the absolute positions last set before the permanent manual control mode. A long-time operation is not tracked, if the output is already in the corresponding end position.
- ❏ The behaviour at the end of the permanent manual control when the bus voltage is off (only manual control) is permanently set to "no change".
- ❏ The control operations triggered in the manual control mode will be transmitted via feedback objects to the bus, if enabled and actively transmitting.
- ❏ On return of bus voltage or after programming with the ETS an activated manual control mode will always be terminated. In this case, the parameterized or predefined behaviour at the end of manual control will not be executed. The actuator executes the parameterized behaviour on bus voltage return or after ETS programming instead.

Presetting a manual control disable

The manual control mode can be separately disabled via the bus, even if it is already active. As soon as a disabling telegram is received via the disabling object in case the disabling function is enabled, the actuator ends an activated manual control mode immediately and interlocks the function keys on the device panel. The telegram polarity of the disabling object is parameterizable.

The manual control mode during bus operation must be enabled.

- Set the parameter "Disabling function ?" on parameter page "Manual control" to "yes".
The disabling function of the manual control mode is enabled and the disabling object is visible.
- Select the desired telegram polarity in the "Disabling object polarity" parameter.
- ❏ If the polarity is "0 = disabled; 1 = enabled", the disabling function is immediately active on return of bus voltage or after an ETS programming operation (object value "0"). To activate the manual control in this case, an enable telegram "1" must first be sent to the disabling object.
- ❏ In case of bus voltage failure, disabling via the disabling object is always inactive (depending on parameterization, the manual control is then either enabled or completely disabled). After return of bus voltage a disabled state that was active before will be reactivated. The disabled state will be deactivated only after an enabling telegram has been received.
In case of supply voltage failure (bus and mains voltage failure), a disable via the disabling object will be deactivated. An interruption of the mains supply alone has no effect on the disabled state of the manual control.
- ❏ When an active manual control is terminated by a disable, the actuator will also transmit a "Manual control inactive" status telegram to the bus, if the status messaging function is enabled.

Presetting the status message function for the manual control mode

The actuator can transmit a status message to the bus via a separate object, when the manual control mode is activated or deactivated. The status telegram can only be transmitted when the bus voltage is present. The polarity of the status telegram can be parameterized.

The manual control mode during bus operation must have been enabled.

- Set the parameter "Transmit status ?" on the "Manual control" parameter page to "yes".
The status messaging function of the manual mode is enabled and the status object is visible.
 - Specify in the parameter "Status object function and polarity" whether the status telegram is generally a "1" telegram whenever the manual control mode is activated or only in those cases where the permanent manual mode is activated.
- ❗ The status object is always "0", when the manual control mode is deactivated.
- ❗ The status will be actively transmitted to the bus ("0") only if a manual control that was activated during bus voltage failure is terminated by the return of the bus voltage. The status telegram is in this case transmitted without delay.
After bus voltage return or after programming with the ETS, the value of the status object is "0" and can also be read out.
- ❗ When an active manual control is terminated by a disable, the actuator will also transmit a "Manual control inactive" status telegram to the bus.

Presetting a bus control disable

Individual switching or shutter outputs can be disabled locally and can then no longer be controlled via the bus. A bus control disable is effected by local operation in the permanent manual mode and indicated by the rapidly flashing status LED of the output concerned. The disabled outputs can then only be actuated in the permanent manual control mode.

The manual control mode during bus operation must have been enabled.

- Set the parameter "Disable bus control of individual outputs during bus operation" on the "Manual control" parameter page to "yes".
The bus control disabling function is enabled and can be activated locally. If "no" is selected for this parameter, the activation of bus control disable in the permanent manual mode is not possible.
- ❗ A locally activated disable has the highest priority. Other functions of the actuator that can be activated via the bus (such as forced position or disabling or safety function) are then overridden. Depending on the parameterization of the actuator in the ETS, the outputs will be set to the state last adjusted in the manual mode or to the state internally tracked (direct operation, forced position, disabling function, safety or sun protection position) when the disabling function is terminated and the permanent manual mode shut off thereafter.
- ❗ A locally activated bus control disable will not be reset in case of bus voltage failure or bus voltage return. Nor will the disable be reset by a mains voltage failure alone. A supply voltage failure (bus and mains voltage failure) will, however, deactivate the bus control disable.

Safety functions for outputs in shutter mode

The switching/shutter actuator can handle up to five different safety functions for the outputs in shutter mode. Each safety function has a communication object of its own so that the functions can be activated or deactivated independently of one another.

Three different wind alarms are available. These alarms can be used, for instance, to protect shutters or awnings on several building facades from wind and gusts. In addition or as an alternative, a rain alarm, for instance, as a protection for awnings, and a frost alarm as a protection against mechanical damage to lowered shutters in low temperatures can be activated and used. The telegram polarity of the safety objects is fixed: "0" = no alarm / "1" = alarm.

As a rule, the communication objects of the safety functions are controlled by weather stations which monitor the temperature, the wind speed and the rainfall by means of sensors.

The safety functions are programmed and configured for all shutter outputs together. The different outputs of the actuator can be separately assigned to all or to individual safety functions. Only assigned outputs react to a change of state of the safety objects. The reactions at the beginning ("1" telegram) or at the end ("0" telegram) of an alarm message can be parameterized for specific channels.

As the outputs can also be assigned to several safety alarms, the priority of incoming alarm messages can be preset for several channels. Thus, the three wind alarms have the same priority with respect to one another (logic OR). The order of priority of the wind alarms with respect to the frost alarm or to the rain alarm can be parameterized

The communication objects for the safety alarms can be monitored for the arrival of cyclical telegrams. If no telegrams are received within a presettable time, the actuator activates the safety travel movement for the outputs assigned. The safety function is terminated when a new "0" telegram is received.

For the wind alarms, the rain alarm and the frost alarm, different monitoring times between '1 minute' and '23 hours 59 minutes' can be separately selected in the ETS. A common time is configured for the wind alarms. Each wind alarm has its own timer so that the wind objects are separately checked for telegram updates.

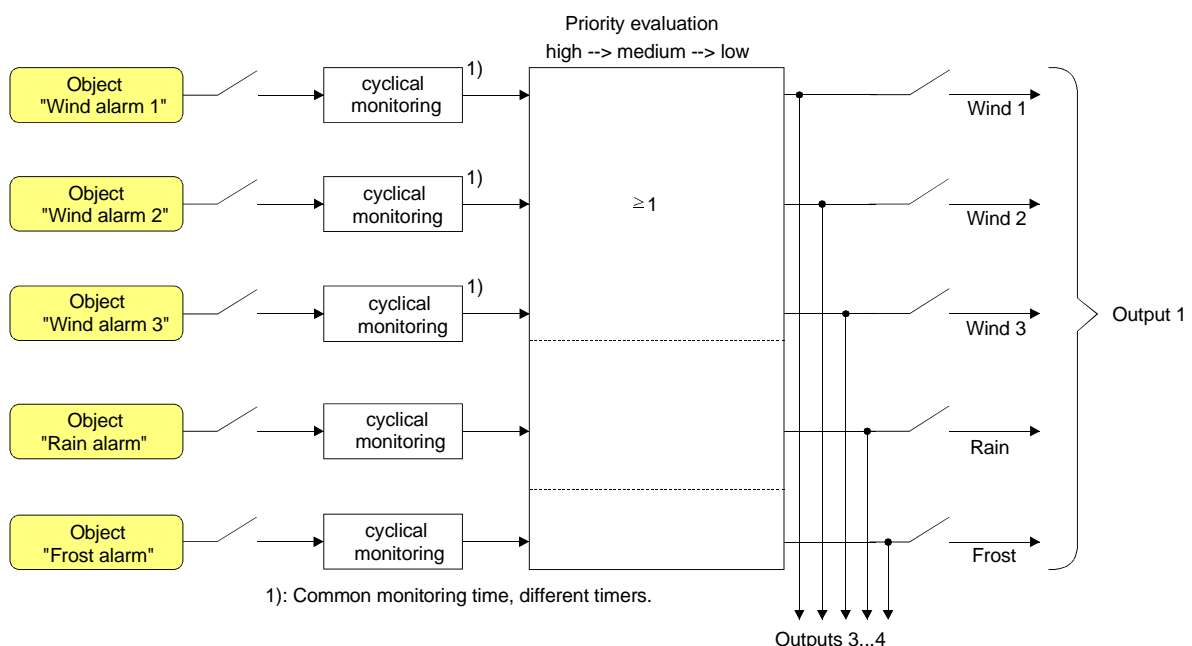

Fig. 10: Function diagram of the safety function

Enabling the safety functions

The safety functions must first be globally enabled before they can be parameterized and used. After global enabling, the individual safety alarms can be enabled or disabled independently of one another.

- Set the parameter "Safety functions" on the "Shutter outputs safety" parameter page to "enabled".
The safety functions are globally enabled and the other parameters and the parameter page "Safety times" become visible.
- Set the parameters "Wind alarm 1", "Wind alarm 2", "Wind alarm 3", "Rain alarm" and "Frost alarm" depending on functional requirements to "enabled". The "disabled" option deactivates the corresponding alarm.
The necessary safety alarms are now enabled. The safety objects are visible and can be linked with group addresses.

- ❗ It should be noted that the channel-oriented assignment of shutter outputs to the safety alarms (on parameter pages "Ax – Safety"; x = number of output) is operational only after the corresponding alarm has been enabled. Otherwise, an assignment is without function.
- ❗ An update of the safety objects ("ON" to "ON" or "OFF" to "OFF") shows no reaction.
- ❗ After failure of the supply voltage (bus and mains voltage failure) or after programming with the ETS, the safety functions are always deactivated. If only the mains voltage or only the bus voltage fails, the object states of the safety functions are not lost and the functions remain activated, if they were activated before. In this case it should be noted, however, that the device executes the parameterized action (parameter "Behaviour after bus or mains voltage return") when the bus or the mains voltage is restored. After such action, the outputs are, however, safety-locked and cannot be operated via the bus anymore unless the safety functions assigned are terminated.

Presetting the safety priorities

If several safety alarms are assigned to an output, it is important to preset the priority of the incoming safety telegrams. An alarm with a higher priority overrides the alarms with the lower priorities. When a safety alarm with the higher priority has ended, the safety alarm with the lower priority is executed on condition that it is active.

The safety functions must have been globally enabled.

- Arrange the "Priority of safety alarms" parameters on the "Shutter outputs safety" parameter page in the required order of priority.
- ❗ The three wind alarms have the same priority with respect to one another (logic OR). The last telegram update to the wind alarm objects decides which of the wind alarms will be executed. The wind alarm is completely deactivated for an assigned output only after all three objects are inactive ("0").

Presetting cyclical monitoring

If cyclical telegram monitoring of the safety objects is necessary, the individual monitoring functions must be activated separately. The monitoring functions must be enabled and the monitoring times preset on the "Shutter outputs safety times" parameter page.

The safety functions must have been globally enabled.

- If monitoring of the wind alarms is to be activated, the parameter "Use wind alarm monitoring function ?" must be set to "yes"

The monitoring function for the wind alarm objects is now activated. As soon as the monitoring function is activated, telegrams must be transmitted cyclically to all enabled wind alarm objects. If only one of the wind alarm telegrams is missing within the monitoring period, the wind alarm reaction will be executed for the output concerned.

- Specify the required monitoring time for the wind alarm objects in the "Wind alarm monitoring times" parameters.
 - If the monitoring function is to be activated for a rain alarm, the parameter "Use rain alarm monitoring function ?" must be set to "yes".
The monitoring function for the rain alarm object is now activated. As soon as the monitoring function is activated, telegrams must be transmitted cyclically to the rain alarm object.
 - Specify the required monitoring time for the rain alarm object in the "Rain alarm monitoring times" parameters.
 - If the monitoring function is to be activated for a frost alarm, the parameter "Use frost alarm monitoring function ?" must be set to "yes".
The monitoring function for the frost alarm object is now activated. As soon as the monitoring function is activated, telegrams must be transmitted cyclically to the frost alarm object.
 - Specify the required monitoring time for the frost alarm object in the "Frost alarm monitoring times" parameters.
- ⓘ The monitoring function for the wind alarms may only be activated, if at least one wind alarm has been activated on the "Shutter outputs safety" page.
- ⓘ The cycle time of the transmitters should be shorter than the monitoring time parameterized in the switching/shutter actuator in order to ensure that at least one telegram can be received during the monitoring time.

Selecting the channel definition

The relay outputs of the switching/shutter actuator can be configured in the ETS either for shutter operation or alternatively for switching operation, with a mixed operation of these two channel modes being possible for the different outputs of the device.

In the shutter mode, the switching/shutter actuator can switch electrically operated blinds, shutters, awnings, venting louvers or similar curtains for 230 V AC. In the switching mode, the actuator alternatively switches electrical consumers such as lighting systems or also extra-low voltages.

The channel definition can be selected separately for each output combination on the parameter page "Selection switching / shutter". Depending on this setting, all channel-dependent parameters and objects are created and displayed.

Depending on the channel definition selected, the outputs can either be programmed as separate outputs (switching operation e.g. A1, A2, A3, A4, ...) or as combined outputs (shutter operation e.g. A1/2, A3/4, ...) with the names of the output objects and the parameter page designations changing accordingly. In the manual control mode, the outputs are also combined as described above.

In the shutter mode, one output of the combination controls one of the travel directions (e.g. A1 – up / A2 – down). The travel directions are interlocked by the actuator application software so that a simultaneous activation of both directions in faultless operation of the switching/shutter actuator is always excluded.



CAUTION!

Risk of relay contact fusion if the actuator is operated outside the scope of its technical specifications (cf. Technical Data). Risk of irreparable damage to connected drive motors, if relay contacts fuse together and if both travel directions are then actuated at the same time.

The actuator must always and exclusively be operated within the limits of the respective technical specifications!

Mechanical interlocking of the travel directions is not provided for since separate control of the outputs in the switching mode must always remain possible.

- Set the parameter "Function of output x and of output y" (x = 1, 3, 5, ... / y = 2, 4, 6,...) to "1 x shutter output".

The corresponding output combination is configured for shutter operation. Both outputs are combined into a shutter channel.

- Set the parameter "Function of output x and of output y" (x = 1, 3, 5, ... / y = 2, 4, 6,...) to "2 x switching output".

The corresponding output combination is configured for switching operation. Both outputs are configured as two switching channels separated from one another.

- ❗ The parameter and object configurations of the individual outputs depend on the parameters of the "Selection switching / shutter" page and are set with the ETS when the channel definition is changed. In this case, parameter settings or assignments of group addresses to objects can get lost. The channel definition should therefore be selected before parameterization of the actuator begins.

4.2.4.2 Channel-oriented functional description

4.2.4.2.1 Functional description for outputs in switching mode

Mode of operation

The relays of a switching output can be parameterized as make or break contacts. This feature offers the possibility of inversion the switching states. The preset mode of operation has consequences for the switching state feedback function.

Setting the mode of operation

The parameter "Mode of operation" exists separately for each output channel on the parameter page "Ax - General" (x = number of output).

- Program the relay contact as "make contact".
Switching state = off ("0") → relay contact open,
Switching state = on ("1") → relay contact closed.
- Program the relay contact as "break contact".
Switching state = off ("0") → relay contact closed,
Switching state = on ("1") → relay contact open.

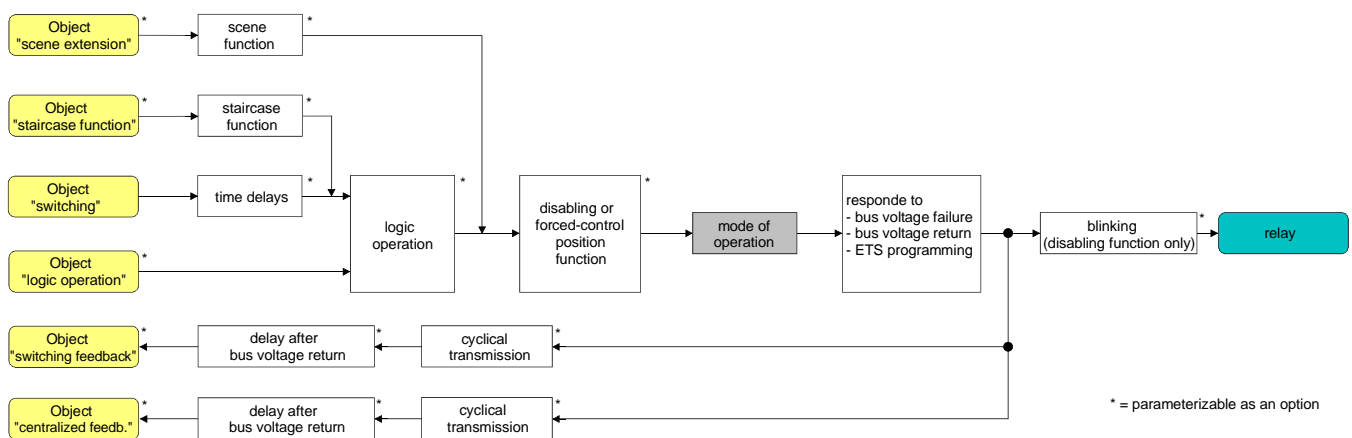

Fig. 6: Functional diagram "Mode of operation"

- ❗ The logic switching state ("on - 1" or "off - 0") is set by the communication object "Switching" and influenced by the functions that can be optionally activated (e.g. timing/staircase functions, logic operations, disabling/forced-control position functions, scenes – cf. Fig. 11).
- ❗ A switching state set after bus/mains voltage return or after an ETS programming operation is tracked in the feedback object. In the event of a mains voltage failure, the actuator transmits switching status feedback telegrams to the bus, if the bus voltage is still on. For this case it should be noted that – independently of the set mode of operation (make or break contact) – all outputs are initialized with the switching state "off - 0" and that the feedback telegram is thus also adapted to this state.

Reaction after bus voltage failure, bus or mains voltage return or after ETS programming

The preferred relay contact positions in case of bus voltage failure, bus or mains voltage return or after ETS programming can be preset separately for each output. Since the actuator is equipped with mains-dependent monostable relays, the relay switching state at bus voltage failure can be defined as well.

Presetting the behaviour after ETS programming

The parameter "Behaviour after ETS programming" can be preset separately for each output channel on the parameter page "Ax - General" (x = number of output). This parameter can be used to parameterize the output relay behaviour independent of the behaviour after bus voltage return.

- Set the parameter to "no reaction".
After ETS programming, the relay of the output shows no response and remains in the switching state last selected. The internal logic switching state is not lost either by an ETS programming cycle.
 - Set the parameter to "close contact".
The relay contact is closed after an ETS programming cycle.
 - Set the parameter to "open contact".
The relay contact is opened after an ETS programming cycle.
- ⓘ The parameterized behaviour will be executed after every application or parameter download by the ETS. Downloading only the physical address or programming the group addresses only partially has the effect that this parameter will be disregarded and the parameterized "Behaviour after bus voltage return" be adopted.
- ⓘ A programming operation with the ETS can be performed when the bus voltage is connected to the switching/shutter actuator and activated. The mains supply is not needed for an ETS download.
- ⓘ During every ETS programming operation, the switching/shutter actuator always opens the relay contacts for all outputs. For this reason, a closed relay contact may open briefly even if the output is set to "no reaction".
- ⓘ A switching state set after an ETS programming cycle will be tracked in the feedback object depending on the "Mode of operation" parameter.
- ⓘ An active manual mode will be terminated by an ETS programming operation.
- ⓘ After an ETS programming operation, the disabling functions and the forced-control positions are always deactivated.

Presetting the behaviour in case of bus voltage failure

The parameter "Behaviour in case of bus voltage failure" can be preset separately for each output channel under "Ax - General" (X = number of output).

- Set the parameter to "no reaction".
In case of bus voltage failure, the relay of the output shows no reaction and remains in the switching state last selected.
 - Set the parameter to "close contact".
The relay contact is closed on bus voltage failure.
 - Set the parameter to "open contact".
The relay contact is opened on bus voltage failure.
- ❗ In the event of bus voltage failure with the settings "close contact" and "open contact", previously activated time delays or previously recalled delayed scenes have no effect on the output concerned. This means that a telegram update received immediately before bus voltage failure is lost, if the corresponding delay time has not yet elapsed.
With the setting "no reaction", delay times (time delay, delayed scene recall) started before bus voltage failure will be evaluated even after bus voltage failure if the mains voltage is still on. The state of an output can therefore still change even after a bus failure.
- ❗ In the event of a mains voltage failure all relays of the actuator will generally drop out (contact open) independently of bus voltage conditions. In this state, the outputs are no longer accessible. Time functions (scene delays, time delays) are not interrupted if only the mains voltage fails.
In the event of a mains voltage failure, switching status feedback telegrams are transmitted to the bus, if the bus voltage is still on. For this case it should be noted that – independently of the set mode of operation (make or break contact) – all outputs are initialized with the switching state "off" and that the feedback telegram is thus also adapted to this state.
- ❗ In case of bus or mains voltage failure, also the current states of the forced-control positions are stored so that they can, if necessary, be restored when the bus voltage returns (depending on the parameterization of the forced-control position functions).
- ❗ Active disabling or forced-control position functions are always deleted by a bus voltage failure and are inactive thereafter.

Presetting the behaviour after bus or mains voltage return

The parameter "Behaviour after bus or mains voltage return" exists separately for each output on parameter page "Ax - General" (x = number of output).

- Set the parameter to "close contact".
The relay contact closes on return of bus or mains voltage.
 - Set the parameter to "open contact".
The relay contact opens on return of bus or mains voltage.
 - Set the parameter to "state as before bus/mains voltage failure".
After bus or mains voltage return, the switching state last set and internally stored before bus/mains voltage failure will be restored.
 - Set the parameter to "activate staircase function (if parameterized)".
The staircase lighting timer function is activated independently of the "Switching" object after bus or mains voltage return. For this setting, it is important that the staircase lighting timer function is enabled and programmed. If the staircase lighting timer function is not enabled, there is no reaction after bus/mains voltage return.
- ❗ When the setting "state as before bus/mains voltage failure" is selected, an application or parameter download with the ETS resets the internally stored switching state to "off – 0".
- ❗ The parameterized "Behaviour after bus or mains voltage return" will only be executed on return of the bus voltage, if the last ETS application or parameter download ended more than ca. 20 s ago. Otherwise ($T_{ETS} < 20$ s), the "Behaviour after an ETS programming operation" will be executed even after return of bus voltage.
If only the mains voltage fails after an ETS download and is then switched on again, the actuator executes the "Behaviour after bus or mains voltage return".
A mains voltage return does not affect communication objects which receive states via the bus (e.g. logic operation inputs). The objects remain in the state last set, if the bus voltage was on without interruption.
- ❗ In case of forced-control as supplementary function: The forced-control communication object can be initialized separately after bus voltage return. An activation of the forced-control function therefore has an influence on the response of the output to bus voltage return. The parameterized "Behaviour after bus or mains voltage return" will only be executed, if no forced-control position is active after bus voltage return!
A failure of the mains voltage supply of the actuator always deactivates a forced-control position.
- ❗ With disabling function as supplementary function: active disabling functions are always inactive after bus or mains voltage return.
- ❗ A switching state existing after bus or mains voltage return will be retained in the feedback object depending on the "Mode of operation" parameter.
- ❗ On return of bus voltage an active manual control will be terminated. Manual control is not possible in case of mains failures.

Switching status feedback

The actuator can return the switching status set at its output ("on" or "off") to the bus (cf. Fig. 12). The returned feedback value can optionally be inverted.

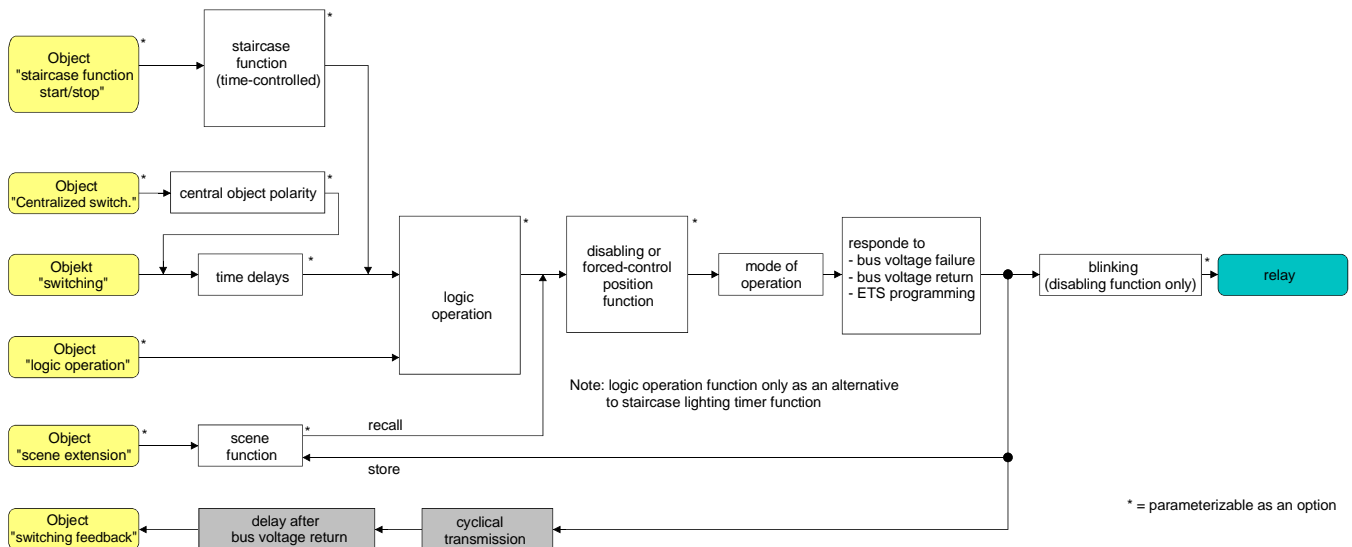

Fig. 12: Functional feedback diagram

Activating the switching status feedback function

The switching status feedback can be used as an active message object or as a passive status object. As an active message object, the switching status feedback information is transmitted to the bus whenever a switching state changes. As a passive status object, there is no telegram transmission after a change. In this case, the object value must be read out. The ETS automatically sets the object communication flags required for proper functioning.

The parameter "Feedback telegram?" can be preset separately for each output channel on the parameter page "Ax - General" (x = number of output).

- Set the parameter to "no inversion, active message object" or to "inversion, active message object".
The feedback object is enabled. Depending on the setting, the switching status is transmitted in non-inverted or in inverted form as soon as a change of state occurs or after the device has been programmed with the ETS. The transmission of telegrams takes place even after return of the bus or mains voltage.
- Set the parameter to "no inversion, passive status object" or to "inversion, passive status object".
The feedback object is enabled. Depending on the setting, the switching status will be transmitted back in inverted or non-inverted form only if the feedback object is read by the bus. No automatic telegram transmission takes place after bus or mains voltage return or after programming with the ETS.

i In case of actively transmitting objects, all status updates from "ON" to "ON" or from "OFF" to "OFF" via the object "Switching" or the object "Central switching" always cause a feedback telegram to be transmitted. If a delay is preset and if the switching state is changed via the object "Switching", the delay period must have elapsed before the feedback will be updated.

- ❏ With disabling function as supplementary function: A 'blinking' output is always reported back as "switched on". Switching status feedback telegrams are also transmitted for disabled outputs, for instance, if the outputs are re-adjusted by a manual operation.
- ❏ Switching state changes as a result of manual operation are also reported back to the bus.

Activating switching status feedback on return of bus voltage or after programming with the ETS

If used as active message object, the switching status feedback information is transmitted to the bus after bus voltage return or after programming with the ETS. In these cases, the feedback telegram can be time-delayed with the delay being preset globally for all outputs together (cf. "Delay after bus voltage return").

- Set the parameter "Time delay for feedback telegram delay after bus voltage return" on parameter page "Ax - General" (x = number of output) to "Yes".
The switching status telegram will be transmitted with a delay after bus voltage return or after programming with the ETS. No feedback telegram is transmitted during a running delay, even if a switching state changes during this delay.
- Set the parameter "Time delay for feedback telegram delay after bus voltage return" on parameter page "Ax - General" (x = number of output) to "No".
The switching status telegram will be transmitted immediately after bus voltage return or after programming with the ETS.

- ❏ In case of a feedback telegram after bus voltage return or after programming with the ETS, the parameterized mode of operation will be evaluated. Examples for a non-inverted switching status feedback telegram:
Mode of operation make contact: contact closed = feedback "on",
Mode of operation make contact: contact opened = feedback "off",
Mode of operation break contact: contact closed = feedback "off",
Mode of operation break contact: contact opened = feedback "on".
- ❏ On activation of the mains voltage (bus voltage already on at this instant) feedback telegrams are always transmitted without delay.

Presetting the cyclical transmission function for the switching status feedback telegram

In addition to being transmitted in case of a state change, the switching status feedback telegram can also be transmitted cyclically via the active message object.

- Set the parameter "Cyclical transmission of feedback telegram?" on parameter page "Ax - General" (x = number of output) to "Yes".
Cyclical transmission is now activated.
 - Set the parameter "Cyclical transmission of feedback telegram?" on parameter page "Ax - General" (x = number of output) to "No".
Cyclical transmission is deactivated which means that a feedback telegram is transmitted to the bus only if one of the switching states changes.
- ❏ The cycle time is defined centrally for all cyclical feedback telegrams on the parameter page "Switching outputs time settings"
 - ❏ During an active delay after bus voltage return no feedback telegram will be transmitted even if a switching state changes.

Time delays

Up to two time functions can be preset independently for each output. The time functions act only on the communication objects "Switching" or "Central switching" (if a central has been activated for the output in question) and delay the received object value as a function of telegram polarity (cf. Fig. 13).

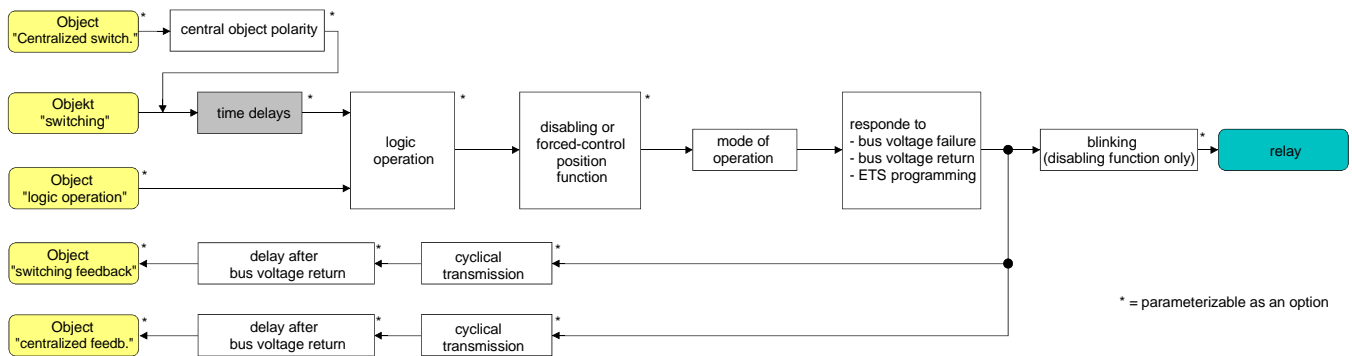

Fig.13: Functional diagram of the time delays

Activating an ON-delay

The time delays must have been enabled on parameter page "Ax – Enabled functions (x = number of output).

- Set the parameter "Selection of time delay" on parameter page "Ax – Time delays" to "ON-delay" or to "ON-delay and OFF delay".

The ON-delay is now enabled and the desired ON-delay time can be preset. After reception of an ON telegram, a parameterized time is started. A subsequent ON-telegram retriggers the time only if the parameter "ON-delay retriggerable ?" has been set to "Yes". The logical switching state will then be transferred to the following functions (e.g. logical operation, disabling / forced-control position function) and the output switched on, only after the ON-delay has elapsed. An OFF-telegram received during the ON-delay will end the delay. The logical switching state corresponds in this case to "switched off".

Activating an OFF-delay

The time delays must have been enabled on parameter page "Ax – Enabled functions (x = number of output).

- Set the parameter "Selection of time delay" on parameter page "Ax – Time delays" to "OFF-delay" or to "ON-delay and OFF delay".

The OFF-delay is now enabled and the desired OFF-delay time can be preset. After reception of an OFF-telegram, a parameterized time is started. A subsequent OFF-telegram retriggers the time only if the parameter "OFF-delay retriggerable ?" has been set to "Yes". The logical switching state will then be transferred to the following functions (e.g. logical operation, disabling / forced-control position function) and the output switched off, only after the OFF-delay has elapsed. An ON-telegram received during the OFF-delay will end the delay. The logical switching state corresponds in this case to "switched on".

- ❶ Feedback: If a time delay has been preset and if the switching state is changed via the "Switching" object, the time delay must have elapsed before feedback telegrams will be transmitted. Updates of the object from "ON" to "ON" or from "OFF" to "OFF" by retriggering during a running time delay has no influence on the switching status feedback.
- ❶ At the end of a disabling or forced-control position function, the state received during or set before the function can be tracked. Residual times of time functions are tracked, if they have not completely elapsed at the time the disabling or forced-control position functions are disabled. In case of a logical operation function, a switching state newly received via the "Switching" object will be executed with a time delay as well.
- ❶ The time delays have no influence on the staircase functions, if these are enabled.
- ❶ A time delay in progress will be completely terminated by a reset of the actuator (bus voltage failure or ETS programming)

Staircase function

The staircase function can be parameterized for each output separately and used for realizing time-controlled staircase lighting or functionally similar applications. The staircase function must have been enabled on parameter page "Ax – Enabled functions" separately for each output before the required communication objects and parameters (on parameter page "Ax – Staircase function") are visible.

The staircase function is controlled by means of the "Staircase function start / stop" communication object and is independent of the "Switching" object of the output (cf. Fig. 14). This feature permits 'parallel operation' of time and normal control, with always the last command being executed.

A telegram to the "Switching" object or a scene recall during an active staircase function ends the staircase time prematurely and sets the output to the switching state corresponding to the object value (time delays taken into account) or the scene value received. Similarly, the switching state of the "Switching" object or a scene recall can be overridden by a staircase timer function.

In combination with a disabling function a time-independent permanent lighting function can also be realized (cf. "Disabling function").

As can be seen from the functional diagram, the staircase function can also be combined with other output functions. The combination with the logic function is, however, not available.

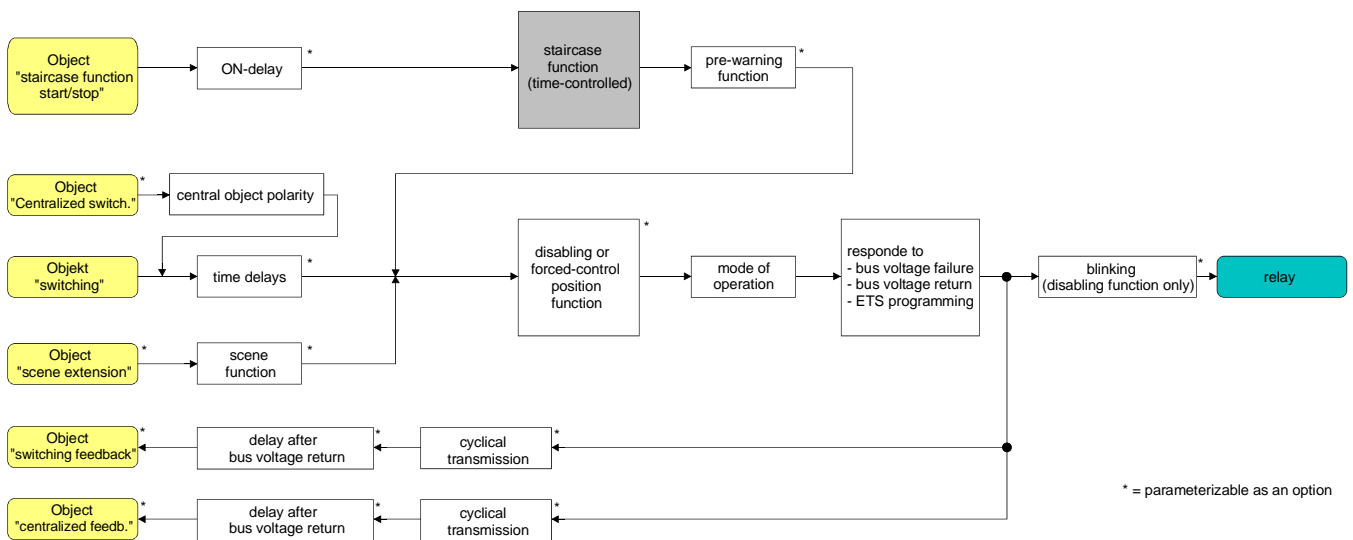

Fig. 14: Functional diagram of the staircase function

The staircase function can moreover be enlarged by a separate ON-delay and by a pre-warning function. In acc. with DIN 18015-2, the pre-warning function is designed to warn a person in the staircase that the lights will go out shortly.

Defining the switch-on behaviour of the staircase function

An ON-telegram to the "Staircase function start / stop" activates the staircase lighting time (T_{ON}) the duration of which is defined by the parameter "Staircase time". In addition, an ON-delay (T_{delay}) can be activated (cf. "Presetting the ON-delay for the staircase function"). At the end of the staircase lighting time, the output switches off or optionally activates the pre-warning time ($T_{pre-warn}$) of the pre-warning function (cf. Presetting the pre-warning function of the staircase function"). With a possible ON-delay and a pre-warning function, the staircase function has the switch-on behaviour as shown in Fig. 15.

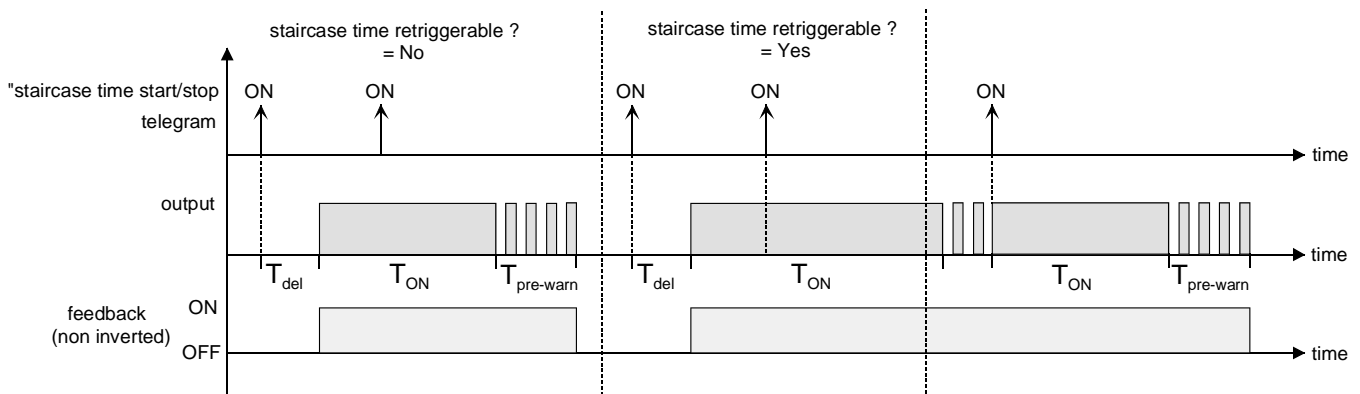

Fig. 15: Switch-on behaviour of the staircase function

The parameter "Staircase time retriggerable ?" defines whether the staircase lighting time can be retriggered or not.

The staircase function must have been enabled on parameter page "Ax – Enabled functions (x = number of output).

- Set the parameter "Staircase time retriggerable ?" to "Yes".
Every ON-telegram received during the ON-phase of the staircase lighting time retriggers the staircase time completely.
- Set the parameter "Staircase time retriggerable ?" to "No".
ON-telegrams received during the ON-phase of the staircase time will be rejected. The staircase lighting time will not be retriggered.

i An ON-telegram received during the pre-warning time always retriggers the staircase lighting time independent of the "Staircase time retriggerable ?" parameter.

Defining the switch-off behaviour of the staircase function

In a staircase function, the reaction to an OFF-telegram to the "Staircase function start / stop" object can also be parameterized. Without reception of an OFF-telegram, the output switches off after the pre-warning time has elapsed. With a possible ON-delay and a pre-warning function, the staircase function has a switch-off behaviour as shown in Fig. 16.

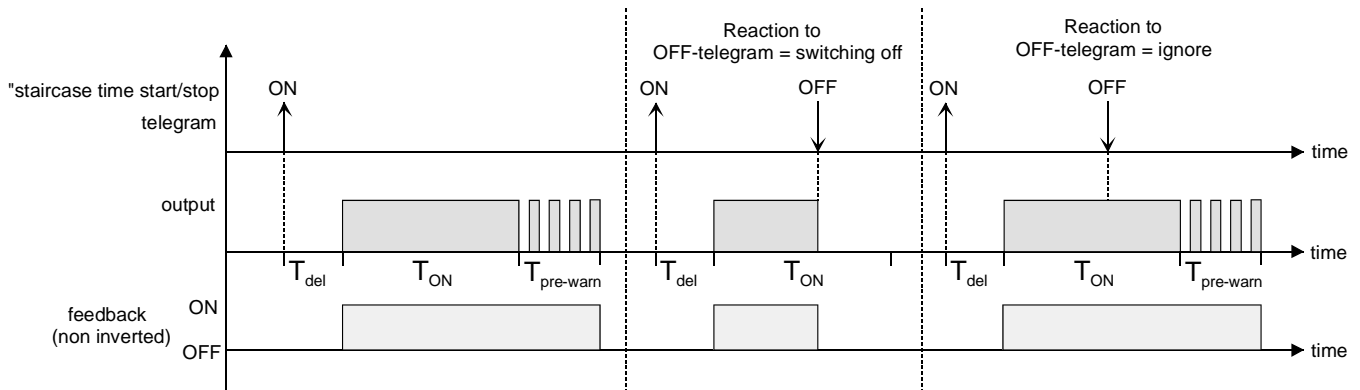

Fig. 16: Switch-off behaviour of the staircase function

The parameter "Reaction to OFF-telegram" defines whether the staircase time (T_{ON}) of the staircase function can be stopped prematurely.

The staircase function must have been enabled on parameter page "Ax – Enabled functions (x = number of output).

- Set the parameter "Reaction to OFF-telegram" to "Switching off"
The output shuts off immediately when an OFF-telegram is received via the object "Staircase function start / stop" during the ON-phase of the staircase time. If the staircase time is stopped prematurely by such a telegram, there is no pre-warning, i.e. the pre-warning time is not started.
- Set the parameter "Reaction to OFF-telegram" to "Ignore".
OFF-telegrams received during the ON-phase of the staircase time will be rejected. The staircase time will be executed completely, if applicable with a pre-warning.

Presetting the ON-delay for the staircase function

An ON-telegram to activate the staircase function can also be evaluated with a time delay. This ON-delay can be activated separately for the staircase function and has no influence on the parameterizable time delays for the "Switching" object.

The staircase function must have been enabled on parameter page "Ax – Enabled functions (x = number of output).

- Set the parameter "Activate ON-delay for staircase function ?" on parameter page "Ax – Staircase function" to "Yes".

The ON-delay for the staircase function is now enabled and the desired ON-delay time can be preset. The ON-delay is started after reception of an ON-telegram to the "Staircase function start / stop" object. A subsequent ON-telegram retriggers the time only if the parameter "ON-delay retriggerable ?" has been set to "Yes". The staircase time is activated and the output switched on only after the time delay has elapsed.

- ❶ An OFF telegram via the "Staircase function start / stop" object during the ON-delay ends the delay only if the parameter "Reaction to OFF telegram" is set to "switching off". Otherwise the OFF telegram will be ignored.

Presetting the pre-warning function of the staircase function

The pre-warning function complies with DIN 18015-2 and is designed to warn a person in the staircase that the lights will go out shortly. As a pre-warning, the lamps connected to the output are switched off several times for a short instant before the output is shut off definitely. The pre-warning time ($T_{pre-warn}$), the duration of the interruptions during the pre-warning ($T_{interrupt}$) and the number of pre-warning interruptions can be parameterized (cf. Fig. 17 - example). The pre-warning time is added to the staircase lighting time (T_{ON}). The pre-warning time has an influence on the value of the feedback object so that the value "0" (non-inverted transmission) is tracked in the feedback object only after the pre-warning time has elapsed.

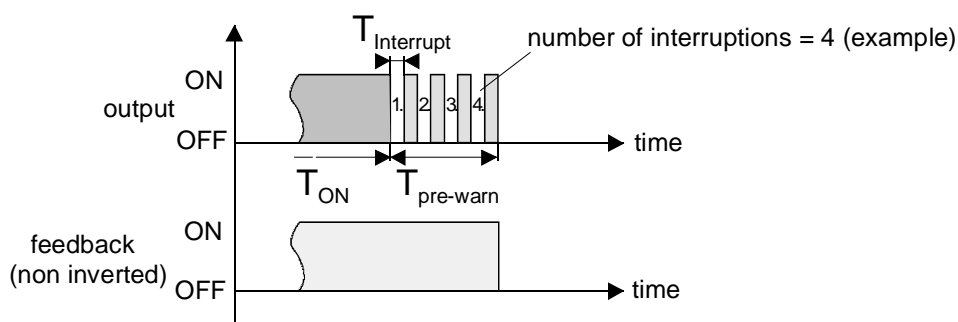

Fig.17: The pre-warning function of the staircase function

The staircase function must have been enabled on parameter page "Ax – Enabled functions (x = number of output).

- Set the parameter "Activate pre-warning time ?" on parameter page "Ax – Staircase function" to "Yes".

The pre-warning function is now enabled and the desired pre-warning time ($T_{\text{pre-warn}}$) can be preset.

- Set the parameter "Number of pre-warnings" on parameter page "Ax – Staircase function" to the desired value (1...10).

The lamps connected to the output will then be switched off exactly as many times as programmed in this parameter. The 1st pre-warning is always executed at the beginning of the total pre-warning time.

- Set the parameter "Time for pre-warning interruptions" on parameter page "Ax – Staircase function" to the desired value.

An interruption ($T_{\text{interrupt}}$) during the pre-warning time is as long as programmed in this parameter. A presettable interruption time permits adapting the shut-off phase of the lighting individually to the lamp type used.

- ❗ It must be ensured that the "Number of pre-warnings" and the "Time for pre-warning interruptions" are coordinated with the length of the total "pre-warning time". Thus, the total shut-off phase during a pre-warning ("Number of pre-warnings" + "Time for pre-warning interruptions") must not be chosen longer than the pre-warning time itself. Otherwise risk of malfunctions.
- ❗ With an ON-telegram to the "Staircase function start / stop" object during an active pre-warning function, the pre-warning time is stopped and the staircase time always restarted (independent of the "Staircase time retriggerable ?" parameter). The parameter "Reaction to OFF-telegram" is also evaluated during the pre-warning time so that an active pre-warning can be terminated prematurely by switching off.

Presetting the behaviour of the staircase function after bus voltage return

The staircase function can optionally be started automatically after bus voltage return.

The staircase function must have been enabled on parameter page "Ax – Enabled functions (x = number of output).

- Set the parameter "Behaviour after bus or mains voltage return" on parameter page "Ax – General" to "Activate staircase function".

The staircase lighting time of the staircase function is started immediately after bus voltage return.

- ❗ For this setting it is indispensable that the staircase function has been programmed and enabled beforehand. When the staircase function has not been enabled, this setting will produce no reaction after return of the bus or mains voltage.
- ❗ During an automatic start of the staircase function after return of the bus or mains voltage, an ON-delay – even if parameterized in the staircase function – will not be started.
- ❗ The device adopts the parameterized behaviour only if the last ETS programming of the application or of the parameters occurred at least ca. 20 s ago. Otherwise ($T_{ETS} < 20$ s), the "Behaviour after ETS programming" will be adopted even after a return of bus voltage.
If only the mains voltage fails after an ETS download and is then switched on again, the actuator executes the "Behaviour after bus or mains voltage return".
- ❗ The parameterized behaviour will only be adopted, if no forced control is activated after a bus voltage return.
- ❗ A switching state set after bus or mains voltage return will be tracked in the feedback object as provided for in the "Mode of operation" parameter.

Scene function (only in ETS 3.0d and onwards)

Up to 8 scenes can be generated and the corresponding scene values stored in the actuator separately for each output in switching mode (only in ETS 3.0d and onwards). The scene values are recalled or stored via a separate scene extension object by means of extension telegrams. The datapoint type of the extension object permits addressing of up to 64 scenes max. For this reason, the scene number (1...64) with which the internal scene (1...8) is addressed can be determined in the parameterization of a scene.

The scene function must have been enabled on parameter page "Ax – Enabled functions" separately for each output before the required communication objects and parameters (on parameter page "Ax – Scenes") are visible.

The scene function can be combined with other functions of the output (cf. Fig. 18) with the command last received or selected always being executed:

A telegram to the "Switching" object or a scene recall or a scene storage telegram during an active staircase function ends the staircase lighting time prematurely and sets the output to the switching state corresponding to the object value (time delays taken into account) or the scene value received. Similarly, the output switching state set by the "Switching" object or a scene recall can be overridden by a staircase function or by the result of a logic function.

A combination of the function with cyclical monitoring is not possible.

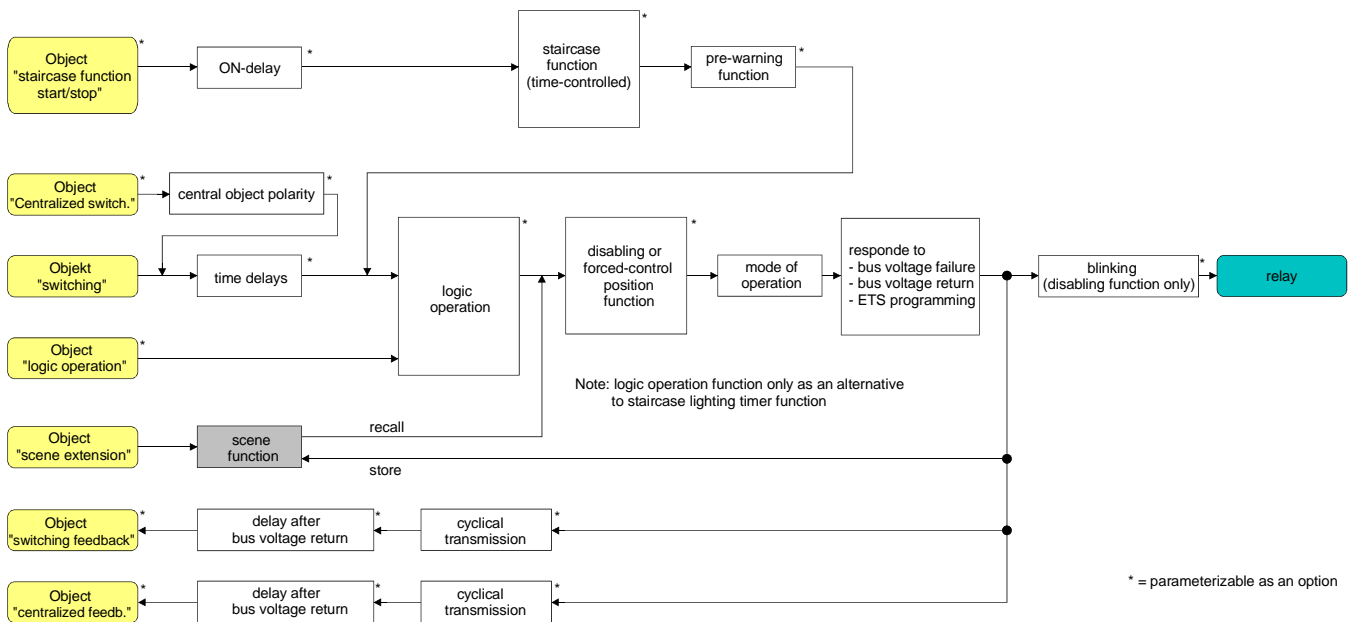

Fig. 18: Functional diagram of the scene function

Presetting a scene recall delay for the scene function

Each scene recall of an output can optionally also be delayed. With this feature, dynamical scene sequences can be configured if several outputs are combined with cyclical scene telegrams.

The scene function must have been enabled on parameter page "Ax – Enabled functions (x = number of output).

- Set the parameter "Delay scene recall?" on parameter page "Ax – Scenes" to "Yes"
The delay time is now activated and can be parameterized separately. The delay only influences the scene recall of the output. The delay time is started on arrival of a recall telegram. The corresponding scene will be recalled and the output set to the respective switching state only after this time has elapsed.
- ❗ Each scene recall telegram restarts the delay time and retriggers it. If a new scene recall telegram is received while a delay is active (scene recall not yet executed), the old (and not yet recalled scene) will be rejected and only the scene last received executed.
- ❗ The scene recall delay has no influence on the storage of scene values. A scene storage telegram within a scene recall delay terminates the delay and thus the scene recall.

Presetting the ETS download behaviour for the scene function

During storage of a scene, the scene values are stored permanently in the device (cf. "Presetting the storage behaviour for the scene function"). To prevent the stored values from being replaced during ETS programming of the application or of the parameters by the originally programmed scene switching states, the actuator can inhibit overwriting of the scene values. As an alternative, the original values can be reloaded into the device during each programming run of the ETS.

The scene function must have been enabled on parameter page "Ax – Enabled functions (x = number of output).

- Set the parameter "Overwrite values stored in the device during download ?" on parameter page "Ax – Scenes" to "Yes".
During each ETS programming of the application or of the parameters, the scene values parameterized in the ETS for the output concerned will be programmed into the actuator. Scene values stored in the device by means of a storage function will be overwritten, if any.
- Set the parameter "Overwrite values stored in the device during download ?" on parameter page "Ax – Scenes" to "Yes".
Scene values stored in the device with a storage function will be maintained. If no scene values have been stored, the switching commands last programmed in the ETS remain valid.
- ❗ When the actuator is put into operation for the first time, this parameter should be set to "Yes" so that the output is initialized with valid scene values. Otherwise, the values in the actuator are "0" (off) for all scenes.

Presetting scene numbers and scene switching state for the scene function

The datapoint type of the scene extension object permits addressing of up to 64 scenes max. For this reason, the scene number (1...64) with which the scene is addressed, i.e. recalled or stored, must be determined for each internal scene (1...8) of the output. Moreover, the switching state to be set for the output in case of a scene recall must be specified as well.

The scene function must have been enabled on parameter page "Ax – Enabled functions (x = number of output).

- Set the parameter "Scene x activatable by scene number" (x = number of the scene (1...8)) for each scene on parameter page "Ax – Scenes" to the numbers with which the scenes are to be addressed. A scene can be addressed with the parameterized scene number. A setting of "0" deactivates the corresponding scene so that neither recalling nor storage is possible.
- ❏ If the same scene number is parameterized for several scenes, only the scene with the lowest internal scene number (1...8) will be addressed. The other internal scenes will be ignored in this case.
- Set the parameter "Switching state for scene x" (x = number of the scene (1...8)) on parameter page "Ax – Scenes" for each scene to the desired switching command ("on" or "off").
In case of a scene recall, the parameterized switching command is recalled and the output is set correspondingly.
- ❏ The output is set to the switching command in a scene recall only if no forced-position or disabling function is active.
- ❏ The parameterized switching command is adopted in the actuator during programming with the ETS only if the parameter "Overwrite values stored in the device during an ETS download ?" is set to "Yes".

Presetting the storage behaviour for the scene function

The logical state established at the output in accordance with the functional diagram ("on" or "off") can be stored internally via the extension object during reception of a scene storage telegram. In this case, the switching state can be influenced before the storage by all functions of the output provided the individual functions have been enabled (e.g. also the disabling function, forced-control position function, manual control).

Rule of thumb: The logical state stored is the one that is reported to the bus by the non-inverted feedback telegram or the one that would have been reported back to the bus had the feedback function not been disabled.

The scene function must have been enabled on parameter page "Ax – Enabled functions (x = number of output).

- Set the parameter "Storage function for scene x" (x = number of the scene (1...8)) on parameter page "Ax – Scenes" for each scene to "Yes".
The storage function is activated for the scene in question. On reception of a storage telegram via the "Scene extension" object, the current logical state will be internally stored.
- Set the parameter "Storage function for scene x" (x = number of the scene (1...8)) on parameter page "Ax – Scenes" for each scene to "No".
The storage function is deactivated for the scene in question. A storage telegram received via the "scene extension" object will be rejected.

Supplementary functions

For each output in switching mode, supplementary functions can be enabled. As supplementary function, a disabling function or alternatively a forced-control position function (only in ETS 3.0d and onwards) can be configured. Only one of these functions can be enabled for an output. Additionally, a logical operation function can be parameterized.

These additional functions are enabled on parameter page "Ax – Supplementary functions " (x = number of output).

Presetting the disabling function as supplementary function

As can be seen from the functional diagram (cf. Fig. 19), the disabling function can also be combined with other output functions. In case of an active disable, the upstream functions are overridden so that the output concerned will be locked in the disabled state. The override feature can also be used to implement a permanent lighting function.

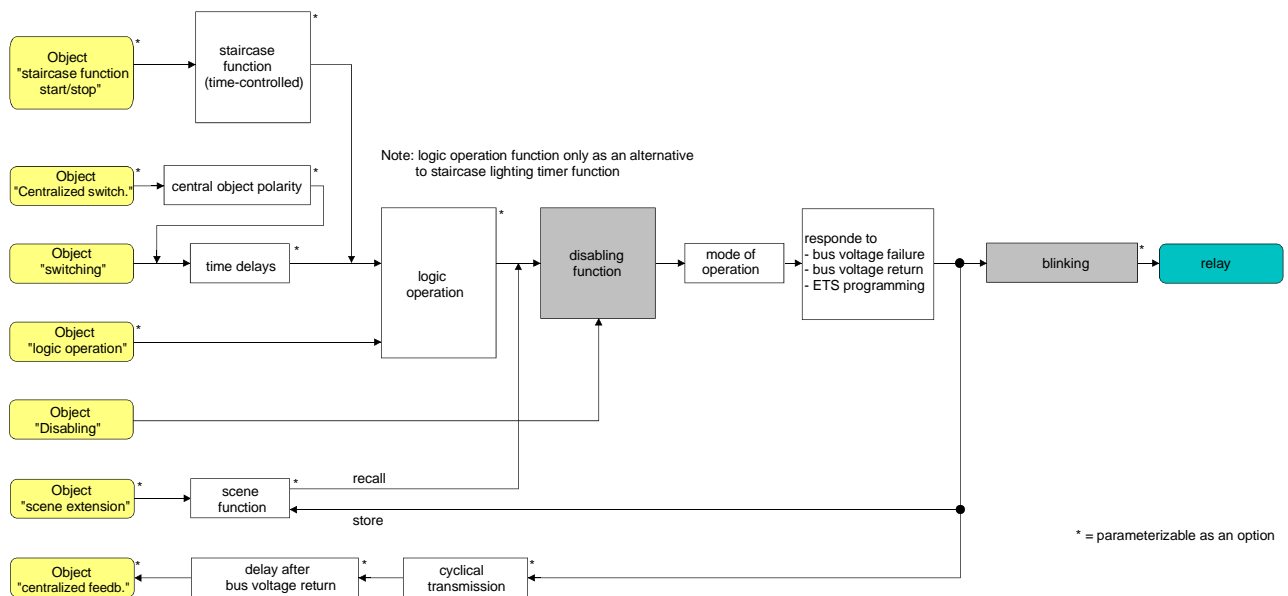

Fig. 19: Functional diagram of the disabling function

- Set the parameter "Selection of supplementary function" on parameter page "Ax – Supplementary functions" to "Disabling function".
The disabling function is enabled. The "Disabling" communication object and the parameters of the disabling function are visible.
- Set the parameter "Polarity of disable object" on parameter page "Ax – Supplementary functions" to the desired polarity.
- ❗ After bus or mains voltage return or programming of the application or of the parameters with the ETS, the disabling function is always deactivated (object value "0"). In the inverted setting ("1 = enabled; 0 = disabled"), a "0" telegram update must first be sent after the initialization before the disabled state is activated.
- ❗ Updates of the disabling object from "ON" to "ON" or from "OFF" to "OFF" show no reaction. The relay remains in the position last set, if applicable also set manually.
- ❗ An output disabled via the bus can still be operated by hand!

- Set the parameter "Behaviour at the beginning of the disabling function" on parameter page "Ax – Supplementary functions" to the desired behaviour.
At the beginning of disabling, the parameterized behaviour will be executed and the output locked. When the setting "No change of switching state" is selected, the relay of the output shows no reaction and remains in the switching state last set (switching state in acc. with last non-inverted feedback telegram). When the setting "Blinking" is selected, the output is switched on and off cyclically during disabling. The blinking time is generally parameterized for all outputs on the "General" parameter page. During blinking, the logic switching state is "ON - 1".
 - Set the parameter "Behaviour at the end of the disabling function" on parameter page "Ax – Supplementary functions" to the desired behaviour.
At the end of disabling, the parameterized behaviour will be executed and the output re-enabled. When the setting "No change of switching state" is selected, the relay of the output shows no reaction and remains in the state last set by the disabling function.
When the setting "Setting tracked state" is selected, the last switching state existing before the disabling function or the switching state internally tracked during the disabling function will be set. In this case, residual times of time functions or of the staircase functions will be tracked as well, if they have not completely elapsed at the time of re-enabling the disabling function. In the settings "No change of switching state", "Switching on", "Switching off" or "Blinking", the states set at the end of the disabling function have no influence on time or staircase functions
When the setting "Blinking" is selected, the output is switched on and off cyclically after disabling. Blinking persists until a new switching state is set. The blinking time is generally parameterized for all outputs on the "General" parameter page. During blinking, the logic switching state is "ON - 1".
- i** The states defined for the end of the disabling function override a logic function if parameterized. The parameterized logic operation will be executed and the result forced on the output only if at least one input state of the logic operation changes or is updated after the disabling state has been suspended.

Presetting the forced-control position function as supplementary function (only in ETS 3.0d and onwards)

As can be seen from the functional diagram (cf. Fig. 20), the forced-control position function can also be combined with other output functions. In case of an active forced-control position function, the upstream functions are overridden so that the output concerned will be locked in the forced position.

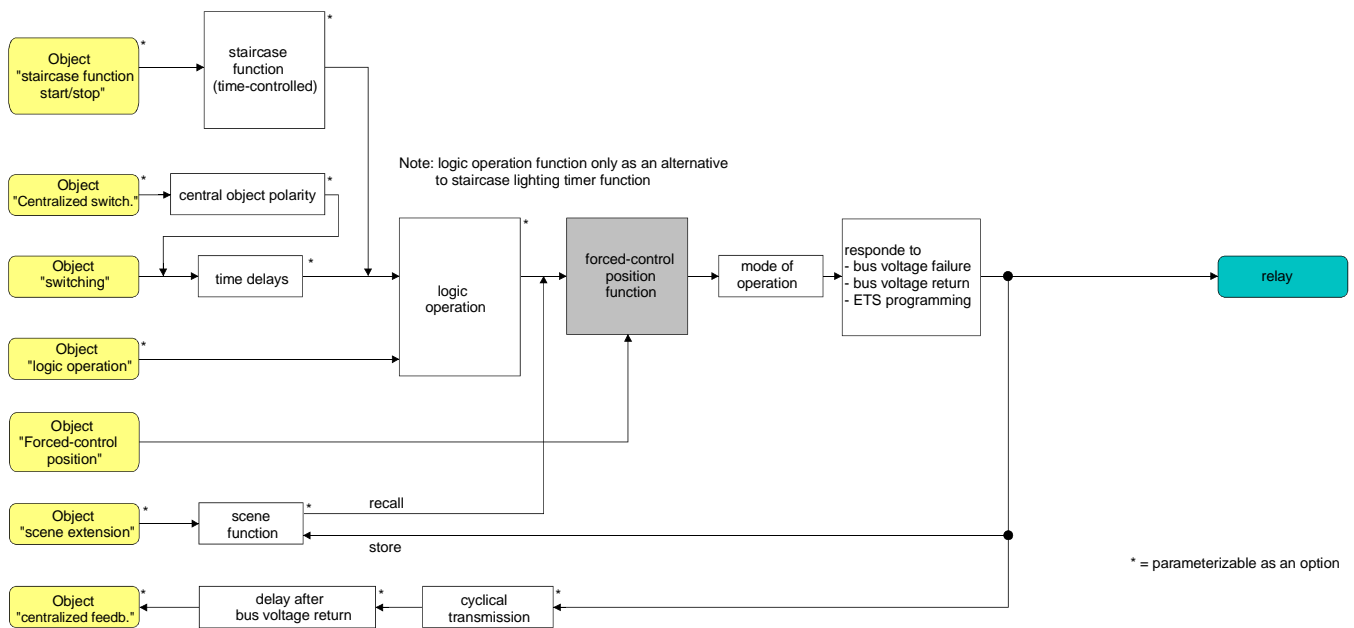

Fig. 20: Functional diagram of the forced-control position function

- Set the parameter "Selection of supplementary function" on parameter page "Ax – Supplementary functions" to "Forced-control position".
The forced-control position function is enabled. The "Forced-control position" communication object and the parameters of the forced-control position function are visible.

In case of the 2-bit forced-control position, the switching state of the output is directly determined by the forced-control position telegram. The first bit (bit 0) of the "Forced-control position" object specifies the switching state to be forced on the output. The second bit (bit 1) activates or deactivates the forced control (cf. table 1).

Bit 1	Bit 0	Function
0	x	forced-control position not active ⇒ normal control
0	x	forced-control position not active ⇒ normal control
1	0	forced-control position active: switching off
1	1	forced-control position active: switching on

Table 1: Bit coding of forced-control position

- ⓘ Updates of the forced-control position object from "Forced-control position ON" to "Forced-control position ON" will cause the relay every time to switch the contact into the forced-control position. Updates from "Forced-control position OFF" to "Forced-control position OFF" remain without effect.
- ⓘ An output under forced control from the bus can still be operated by hand!

- Set the parameter "Behaviour at the end of the forced-control position function" on parameter page "Ax – Supplementary functions" to the desired behaviour.

At the end of the forced-control position function, the parameterized behaviour will be executed and the output re-enabled for normal control. When the setting "No change of switching state" is selected, the relay of the output shows no reaction and remains in the state last set by the forced-control position function.

When the setting "Tracking the switching state" is selected, the switching state last existing before forced control or the one tracked internally while the forced-control position function was active will be set at the end of the forced-control position function. In this case, residual times of time functions or of the staircase functions will be tracked as well, if they have not completely elapsed at the time of re-enabling the disabling function. In the settings "No change of switching state", "Switching on" or "Switching off", the states set at the end of the forced-control position function have no influence on time or staircase functions.

- ❗ The states defined for the end of the forced-control position function override a logic function if so parameterized. The parameterized logic operation will be executed and the result forced on the output only if at least one input state of the logic operation changes or is updated after the forced-control state has been suspended.

The communication object of the forced-control position function can be initialized after bus voltage return. In this way, the switching state of the output can be influenced when the forced-control position function is activated.

- Set the parameter "Behaviour after bus voltage return" on parameter page "Ax – Supplementary functions" to the desired behaviour.

After bus voltage return, the parameterized state is adopted in the "Forced-control position" communication object. In case of an active forced position, the output will be switched immediately after bus voltage return to the corresponding state and locked by forced control until the forced-position condition is cancelled via the bus. The parameter "Behaviour after bus voltage return" will in this case not be evaluated for the output concerned.

If "State of forced-control as before bus voltage failure" is selected, the forced-control is set to the state which was stored in a non-volatile memory at the time of bus voltage failure. After programming of the application or of the parameters with the ETS, the value is in this case always internally set to "Not active".

- ❗ In case of actuator mains supply failure, the forced-control position is always deactivated. The forced-control position is not re-activated even if the mains voltage is absent when the bus voltage returns. In this case, the parameter "Behaviour after bus or mains voltage return" on parameter page "Ax – General" will be executed.
- ❗ After bus voltage return or programming of the application or of the parameters with the ETS, the forced-control position function is always deactivated (object value "0").
- ❗ The parameterized "Behaviour after bus voltage return" of the forced-control position will only be executed on return of the bus voltage, if the last ETS application or parameter download ended more than ca. 20 s ago. Otherwise ($T_{ETS} < 20$ s), the forced-control position will not be activated on return of bus voltage and the "Behaviour after an ETS programming operation" executed.

Presetting the logic function as supplementary function

A logic function can be parameterized separately and independently for each output. This function permits linking the state of the "Switching" object with an additional logic operation object. The state of the communication object for "Switching" can also be evaluated with a delay when an ON-delay or an OFF-delay are defined.

As can be seen from the functional diagram (cf. Fig. 21), the logic function can also be combined with other output functions. A combination with the staircase or the cyclical monitoring function is, however, not possible.

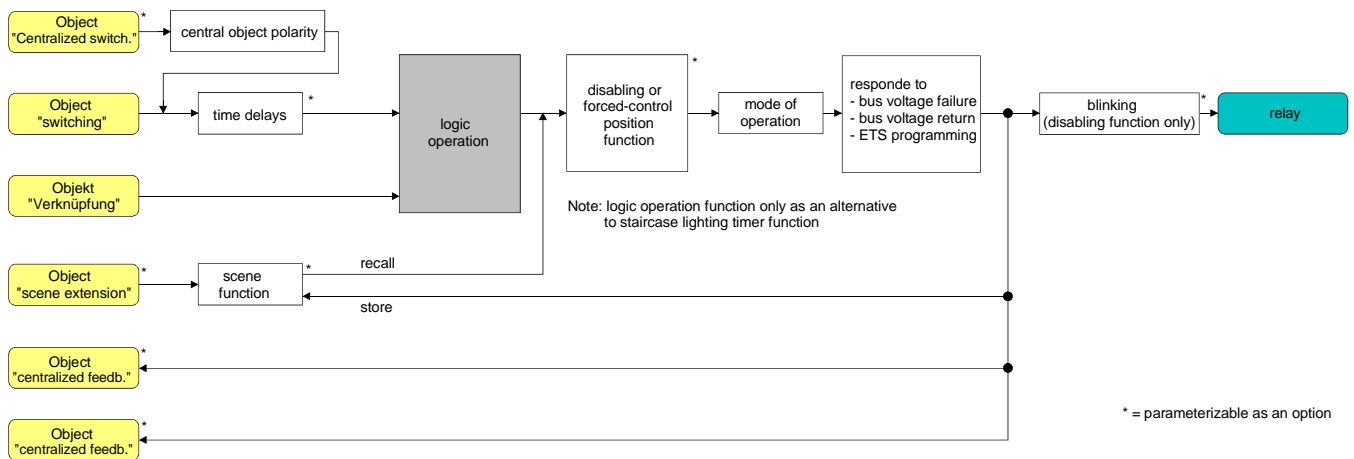

Fig. 21: Functional diagram of the logic function

The following gating operations can be parameterized (cf. Fig. 22)

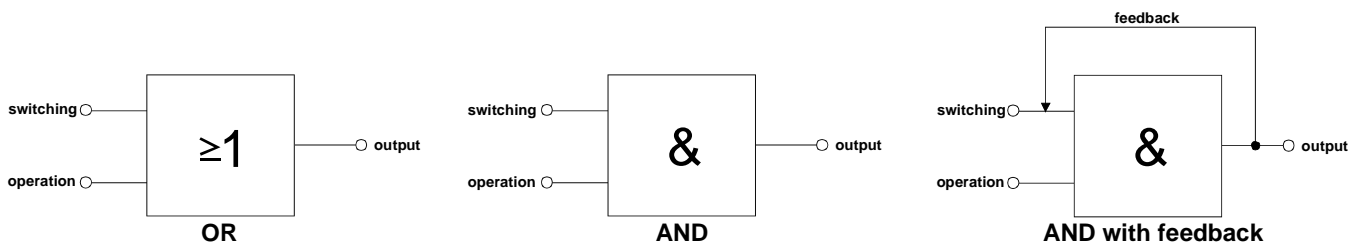

Fig. 22: Gating operations of the logic function

i "AND with feedback:"

With a logic object = "0", the output is always "0" (logic AND). In this case, the feedback signal from the output to the "switching" input will directly reset this input when it is being set. Only if the logic operation object = "1", can the output adopt the logic state "1" after a new "1" has been received on the "Switching" input.

The "Logic operation" object can be initialized after bus voltage return or programming with the ETS with a previously parameterized value so that in case of a telegram update to the "Switching" object a correct operation result is determined immediately and the output set correspondingly.

- Set the parameter "Logic operation function ?" on parameter page "Ax – Supplementary functions" to "Yes".

The logic function is enabled. The "Logic operation" communication object and the parameters of the logic function are visible.

- Set the parameter "Type of logic operation" on parameter page "Ax – Supplementary functions" to the desired type of logic operation.
- Set the parameter "Value of logic operation object after bus voltage return" and "Value of logic operation object after ETS download" on parameter page "Ax – Supplementary functions" to the desired initial conditions.

After bus voltage return or after ETS programming of the application software or of the parameters, the "Logic operation" object is initialized with the preset switching states".

- ❏ After an actuator reset (bus voltage return or ETS programming), the logic function will be executed only if at least one input object of the logic operation is updated by means of a telegram from the bus.
- ❏ The states preset for the end of a disabling or forced-control position function or the switching states that are set after ETS programming, bus voltage failure or after bus or mains voltage return will override the logic function. The parameterized logic operation will be executed and the result forced on the output only if at least one input state of the logic operation changes or is updated.
- ❏ A mains voltage return does not affect the logic operation communication objects. The objects remain in the state last set, if the bus voltage was on without interruption.

4.2.4.2.2 Functional description for outputs in shutter mode

Mode of operation

Each output of the switching/shutter actuator can be independently configured for the drive type connected by defining the mode of operation. The actuator permits controlling slatted blinds, shutters, awnings and also venting louvers. Depending on the preset mode of operation, the ETS adapts the parameters and communication objects for all functions of an output. This means, for instance, that the "blind" mode has also parameters and objects for the slat control. In the "shutter / awning" mode there is no slat control, but a fabric-stretching function parameter instead when awnings are used. In the "venting louver" mode, a distinction is made between "closing" and "opening" movements instead of upward or downward travels as in case of blinds or shutters.

In this documentation, blinds, shutters or awnings are also designated with the term "curtain", if the text does not explicitly refer to a particular function (e.g. slat control).

In all modes it is possible to specify positions.

Presetting the mode of operation

The parameter "Mode of operation" exists separately for each shutter output on the parameter page "Ax - General" (x = number of output).

- Select the required mode of operation in the "Mode of operation" parameter.

- ❗ The "Mode of operation" parameter has an influence on many channel-oriented parameters and communication objects. When the mode of operation is changed in the ETS, the parameters are adapted dynamically so that settings already made or links between group addresses can be reset. For this reason, the required mode of operation should be parameterized at the beginning of the channel-oriented device configuration.
- ❗ Venting louvers must be connected to the outputs in such a way that they are opened in travel direction "up - ▲" and closed in travel direction "down - ▼".
- ❗ An awning travels upwards when it is rolled up.

Behaviour in case of bus voltage failure, after bus or mains voltage return or after programming with the ETS

The preferred relay contact positions in case of bus voltage failure, bus or mains voltage return or after ETS programming can be preset separately for each output. Since the actuator is equipped with mains-dependent monostable relays, the relay switching state at bus voltage failure can be defined as well.

Presetting the behaviour after ETS programming

The parameter "Behaviour after ETS programming" can be preset separately for each output channel on the parameter page "Ax - General" (x = number of output). This parameter can be used to define the output relay behaviour independent of the behaviour after bus or mains voltage return.

Depending on the selected mode of operation, the ETS adapts the designations of the parameter settings ("raising" ↔ "opening the louver" / "lowering" ↔ "closing the louver")

- Set the parameter to "stop".
After programming with the ETS, the actuator switches the relays of the output to the "stop" position and a travel movement in progress is stopped.
- Set the parameter to "raising" or "opening the louver".
After programming with the ETS, the actuator raises the curtain or opens the venting louver.
- Set the parameter to "lowering" or "closing the louver".
After programming with the ETS, the actuator lowers the curtain or closes the venting louver.

- ⓘ At the beginning of each ETS programming cycle, the switching/shutter actuator always executes a "stop" command for all outputs. The manual mode, if active, will be terminated.
- ⓘ The "Behaviour after ETS programming" as parameterized will be executed after every ETS application or parameter download. A simple download of the physical address alone or partial programming of only the group addresses has the effect that this parameter is disregarded and that the parameterized "Behaviour after bus or mains voltage return" will be executed instead. For outputs with end position detection also the travelling times learnt will be retained in this case.
- ⓘ Programming with the ETS is possible when the bus voltage line is connected to the switching/shutter actuator and the bus voltage supply is on. An ETS download does not require the mains voltage supply to be on. If programming with the ETS was performed with bus voltage only, the parameterized "Behaviour after ETS programming" will only be executed when also the mains voltage supply of the actuator has been switched on. The "Behaviour after bus or mains voltage return" will not be activated in this case !
This reaction must be taken into account especially with actuators that are installed in pre-programmed condition into an existing electrical installation.
- ⓘ After programming with the ETS, the safety functions, the forced positions and the sun protection function are always deactivated.

Presetting the behaviour in case of bus voltage failure

The parameter "Behaviour in case of bus voltage failure" can be preset separately for each output channel under "Ax - General" (x = number of output). The parameter defines the behaviour of a shutter output if only the bus voltage fails. The parameterized behaviour will not be adopted, if a manual control mode is active at the time of bus failure (state LEDs blinking in case of temporary or permanent manual control).

Depending on the selected mode of operation, the ETS adapts the designations of the parameter settings ("raising" ↔ "opening the louver" / "lowering" ↔ "closing the louver").

- Set the parameter to "stop".
In case of bus voltage failure, the actuator switches the relays of the output to the "stop" position. A downward travel movement, if any, will be interrupted.
 - Set the parameter to "raising" or "opening the louver".
After bus voltage failure, the actuator raises the curtain or opens the venting louver.
 - Set the parameter to "lowering" or "closing the louver".
After bus voltage failure, the actuator lowers the curtain or closes the venting louver.
 - Set the parameter to "position approach".
In case of bus voltage failure, the connected drive can approach a position specified by further parameters (0...100 %). If blinds are controlled with the device, the slats can be positioned independently. The shutter actuator performs a reference travel before the position approach, if the current position at the time of bus failure is unknown (e.g. due to power supply failure or to previous ETS programming).
 - Set the parameter to "no reaction".
In the event of bus voltage failure, the relay of the output shows no reaction. Motions still in progress at the time of failure will still be completed as long as the mains voltage supply is still on.
- ❗ Safety, forced position or sun protection functions (independent of the selected priority) remain active even after a bus voltage failure as long as the mains voltage supply is still on. These functions will therefore be executed again at the end of a temporary or permanent manual control (if enabled in case of bus failure) even if there is no bus voltage.
- ❗ When the still ongoing motion or the motion parameterized in case of bus voltage failure has come to an end, the outputs can no longer be activated except by manual control (if the mains voltage is on and if manual control is enabled) or by bus/mains voltage return.
- ❗ A bus voltage failure will in any case result in a stop of all time functions. Thus, all scene recalls in the delay phase will be aborted and all delay times for sun protection and presence will be ended by ignoring the object value last received and still in the delay phase. A telegram update received shortly before bus voltage failure is then lost, if the corresponding delay has not yet elapsed.
- ❗ In the event of a mains voltage failure, all relays of the actuator will always drop out ("stop") independent of the bus voltage condition. In this state, the outputs are no longer selectable. Time functions (scene, sun protection and presence delays) are not interrupted, if only the mains voltage fails.

i In case of bus or mains voltage failure, the current position data of the outputs are permanently stored in the device so that the corresponding positions can be precisely tracked after bus or mains voltage return, if so parameterized. The data are stored before the reaction parameterized for the case of bus voltage failure takes place and only if one part of the supply (mains or bus) is still present, or if the supply fails completely after the mains voltage has been available before without interruption for at least 20 seconds after the last reset (storage capacitors sufficiently charged for storage purposes). The data will not be stored, if the position data are unknown. Storage takes place only once after part of the supply voltage has failed...

Example 1:

Bus voltage failure → storage → thereafter mains voltage failure → no further storage,

Example 2:

Mains voltage failure → storage → thereafter bus voltage failure → no further storage.

The following rules apply for the position data to be stored:

The current curtain, slat and louver positions are stored. With blinds, the height to be stored is always referred to a slat position of 100 % (cf. "Calculating the slat position").

Positions temporarily approached will be stored also for those outputs that are involved in a travel movement at the time of data storage.

On account of the fact that position data are stored as integer percentage values (0...100), a minor deviation from the positions reported back later during bus or mains voltage return (number range 0..255) cannot be avoided.

As the position values are stored only once during bus voltage failure, such positions as are varied by manual control after bus voltage failure cannot be tracked. Similarly, forced position telegrams received via the bus after a mains voltage failure or slat offset positions for the sun protection function cannot be stored and tracked either.

Stored position data are not lost during programming with the ETS.

i In case of bus or mains voltage failure, the current states of the forced position control (only in ETS 3.0d and onwards) or – if parameterized – also the slat offsets of the sun protection positions are stored as well.

Presetting the behaviour after bus or mains voltage return

The parameter "Behaviour after bus or mains voltage return" can be preset separately for each output channel under "Ax - General" (x = number of output).

Depending on the selected mode of operation, the ETS adapts the designations of the parameter settings ("raising" ↔ "opening the louver" / "lowering" ↔ "closing the louver").

- Set the parameter to "stop".
In case of bus or mains voltage return, the actuator switches the relays of the output to the "stop" position. A travel movement, if any, will be interrupted.
 - Set the parameter to "raising" or "opening the louver".
After bus or mains voltage return, the actuator raises the curtain or opens the venting louver.
 - Set the parameter to "lowering" or "closing the louver".
After bus or mains voltage return, the actuator lowers the curtain or closes the venting louver.
 - Set the parameter to "position during bus / mains failure"
After bus or mains voltage return, the position value (including the slat position in the case of blinds) last selected and stored internally before bus or mains voltage failure will be tracked. The shutter actuator performs a reference travel before the position approach, if the current position at the time of bus or mains voltage return is unknown (e.g. due to complete power supply failure or to previous ETS programming).
 - Set the parameter to "position approach".
In case of bus or mains voltage return, the connected drive can approach a position specified by further parameters (0...100 %). If blinds are controlled with the device, the slats can be positioned independently. The shutter actuator performs a reference travel before the position approach, if the current position at the time of bus or mains voltage return is unknown (e.g. due to complete power supply failure or to previous ETS programming).
 - Set the parameter to "no reaction".
In the event of bus or mains voltage return, the relay of the output shows no reaction. Ongoing travel movements at the time of voltage return are completed.
- ❗ "Position during bus / mains failure" setting: If no position values could be stored in case of bus or mains voltage failure because the position data were unknown (no reference travel executed), the actuator shows no reaction with this parameterization either.
- ❗ "No reaction" setting: The commands received via the bus during a mains voltage failure (bus voltage present) are tracked when the mains voltage returns. Interrupted short- or long-time travel movements – if not completed – are restarted at full length and position approaches are continued from the break point.

- ❶ All time functions (scene, sun and presence delay) are only stopped in case of bus voltage failure so that a mains voltage failure does not result in a loss of states or time functions as long as the bus voltage is present.
- ❶ The parameterized behaviour is always executed independent of the current states of the safety or sun protection function. Safety and sun protection function can nonetheless be active even after bus or mains voltage return, if these functions have been activated before a bus voltage failure or before or during a mains voltage failure. Any direct operation can thus be overridden. Only in case of a complete supply failure (bus voltage and mains voltage) are the sun protection or the safety functions deactivated.
- ❶ The communication object of the forced position function (only in ETS 3.0d and onwards) can be initialized separately after bus voltage return. This has an effect on the reaction of the output when the forced position is activated. A mains failure alone has no effect on the forced position. In case of a return of only the mains voltage, a previously activated forced position remains active. The parameterized "Behaviour after bus or mains voltage return" will only be executed, if no forced position function is activated after bus voltage return.
- ❶ An active manual control is terminated on return of bus voltage. In case of mains failure, no manual control is possible.
- ❶ The device executes the parameterized "Behaviour after bus or mains voltage return" only if more than ca. 20 s have elapsed between the last ETS download of the application or of the parameters and the time when bus and mains voltage are restored. Otherwise ($T_{ETS} < 20$ s), the "Behaviour after ETS programming" will be executed also in case of a bus/mains voltage return. If only the bus or the mains fails after an ETS download and is then restored, the actuator executes the "Behaviour after bus or mains voltage return".

Determining and configuring short-time and long-time operation

The short-time operation (Step) permits adjusting the slat tilting angle of a blind or the 'slit opening width' of a shutter. In most cases, short-time operation is activated by pressing a blind/shutter pushbutton sensor permitting manual intervention in the blind/shutter control cycle. When the actuator receives a short-time command while the blind, shutter, awning or louver is in motion, the travel movement is stopped immediately by the switching/shutter actuator.

The long-time operation (Move) is determined by the travelling time of the connected blind, shutter, awning or louver and must therefore not be preset separately. The travelling time must be measured 'manually' and the parameters entered in the ETS. The control of an output by means of a long-time or a short-time telegram is also designated as 'direct operation'.

To ensure that the curtain or the louver has definitely reached its end position at the end of long-time operation, the switching/shutter actuator always prolongs the long-time travel movement by 20% of the parameterized or learnt travelling time.

The parameterized travelling time extension will moreover be taken into account by the actuator for all upward travels or all travel movements into the open position as the drive motors are then generally not so fast due to the weight of the curtains or to external physical influences (e.g. temperature, wind, etc.). Thus, it is ensured that the upper end position is always reached even in case of uninterrupted long-time travel movements.

- ❗ A long-time or a short-time operation can be retrIGGERED by a new incoming long-time or short-time telegram.
- ❗ A travel movement activated in the manual control mode or by a safety function is always a long-time operation. The "raising" or "lowering" commands parameterized in the ETS will equally activate the long-time operation.

Presetting the short-time operation

The short-time operation is parameterized separately for each output and independent of the travelling time of the curtain or of the louver. The project designer can specify in the ETS whether the output executes only a "stop" for a travel movement on reception of a short-time telegram or whether the output is activated for a specific duration.

- Set the parameter "Short-time operation" on parameter page "Ax - Time settings" (x = number of output) to "yes".
The switching/shutter actuator activates the output concerned for the time specified under "Duration of short-time operation" when a short-time telegram is received and when the output is not in the process of executing a travel movement. If the output is executing a travel movement at the time of telegram reception, the output will only just stop.
 - Set the parameter "Short-time operation" on parameter page "Ax - Time settings" (x = number of output) to "no (only stop)".
The switching/shutter actuator will only stop the output on reception of a short-time telegram, if the output is in the process of executing a travel movement. There will be no reaction, if the output is not executing a travel movement at the time of telegram reception.
- ❗ The parameterized "Duration of short-time operation" should correspond for a blind to ca. ¼ of the complete slat moving time and for a shutter to the full time needed for opening the shutter segments.
 - ❗ The short-time operation is always executed without travelling time extension.

Determining and configuring travelling times

For computing positions and also for executing long-time operation, the switching/shutter actuator needs the exact travelling time of the connected blind, shutter, awning or louver. The travelling time for a shutter output must be measured 'manually' and entered as a parameter into the ETS. It is important to determine the travelling time accurately to permit positions to be approached with good precision. Therefore, it is recommended to make several time measurements and to take the average of these values before entering them into the corresponding parameter.

The travelling time corresponds to the duration of a travel movement from the completely open position (upper end position / awning rolled up) to the completely closed position (lower end position / awning completely unrolled) and not vice versa! Fig. 23 is a schematic showing the determination of the travelling time as a function of the different types of movements.

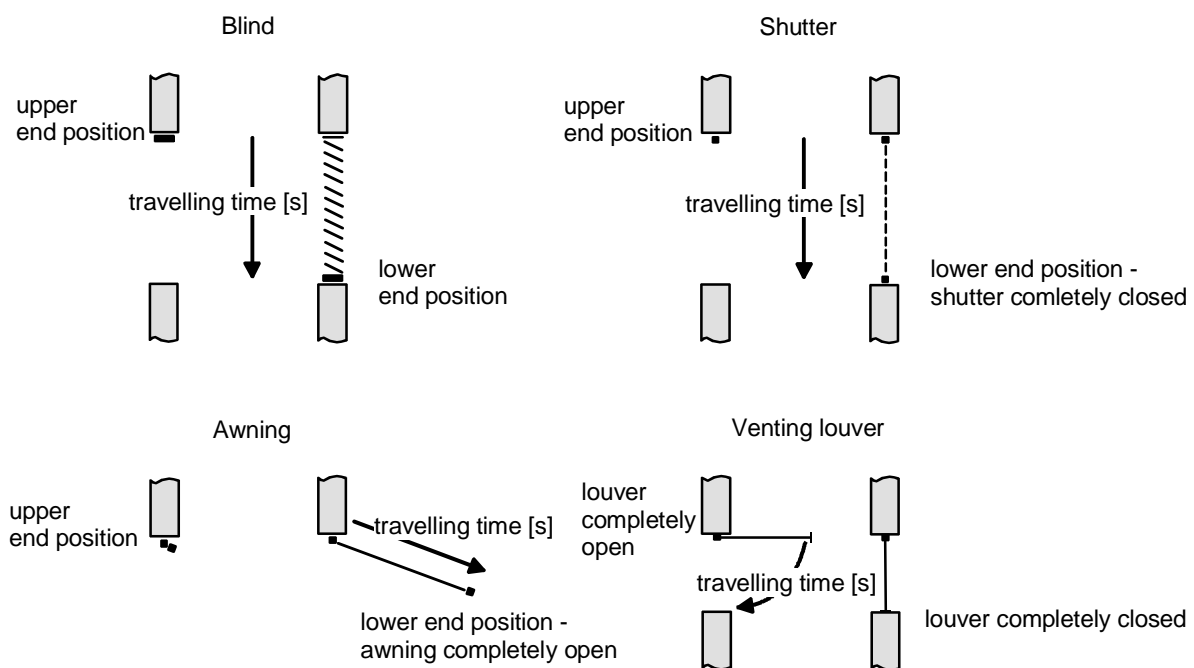

Fig. 23: Travelling time as a function of the type of movement

Presetting the travelling time of blinds, shutters, awnings and louvers without automatic end position detection

The measurement of the travelling time is described in detail in chapter "2.4 Commissioning".

The automatic end detection position must be deactivated.

- Enter the exact travelling times determined in the course of the commissioning procedure into the parameters "Blind travelling time" or "Shutter/awning travelling time" or "Venting louver travelling time" on parameter page "A1 – Time settings" (x = number of output). The maximum travelling time is '59 minutes 59 seconds. The working principle does not allow longer travelling times.
- i** The parameterized travelling time extension will moreover be taken into account by the actuator for all upward travels or all travel movements into the open position as the drive motors are then generally no so fast due to the weight of the curtains or to external physical influences (e.g. temperature, wind, etc.).

Determining and configuring the slat moving time (only with slatted blinds)

If blinds are used, the slats can be positioned independently. To enable the switching/shutter actuator to compute slat positions and to report them back to the bus, it is necessary that the actuator gets precise information about the time required for a slat rotation. The slat moving time must in each case be determined 'manually' and entered into the parameters.

The switching/shutter actuator is designed for controlling single-motor shutter drives without working position. In this drive mode, the slats are directly adjusted by way of mechanical linkage when the height of the blind is changed. The actuator assumes that the slats are completely closed when the blind moves downwards. The actuator assumes that the slats are completely closed when the blind moves downwards (cf. Fig. 24). These blinds are the most common type on the market.

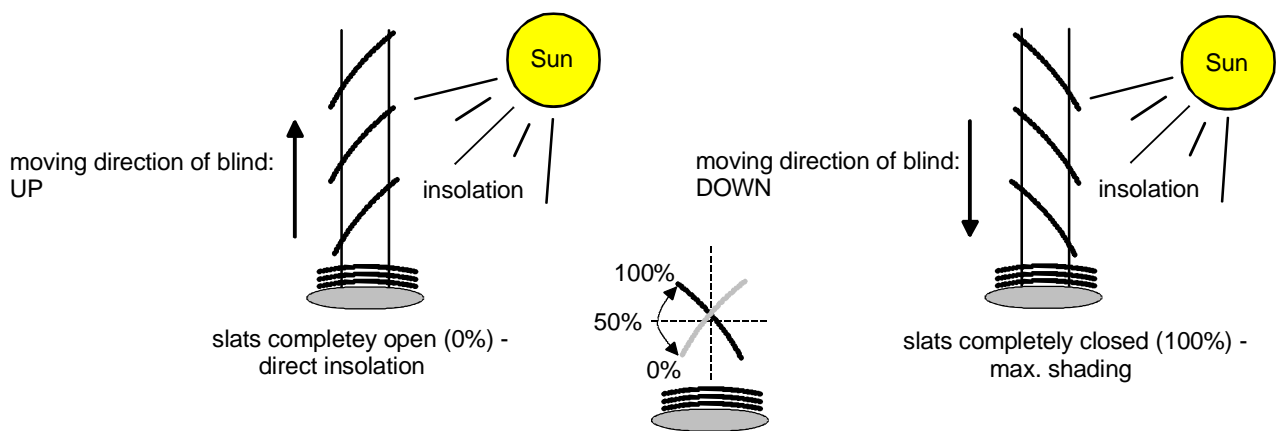

Fig. 24: type 1 - slatted blinds with oblique slat position in both travel directions

There are also single-motor blind systems without working position the slats of which are horizontal during an upward travel and oblique during a downward travel. Such blind types can also be connected to the actuator in which case a completely open slat position corresponds to the slats in horizontal position (cf. Fig. 25).

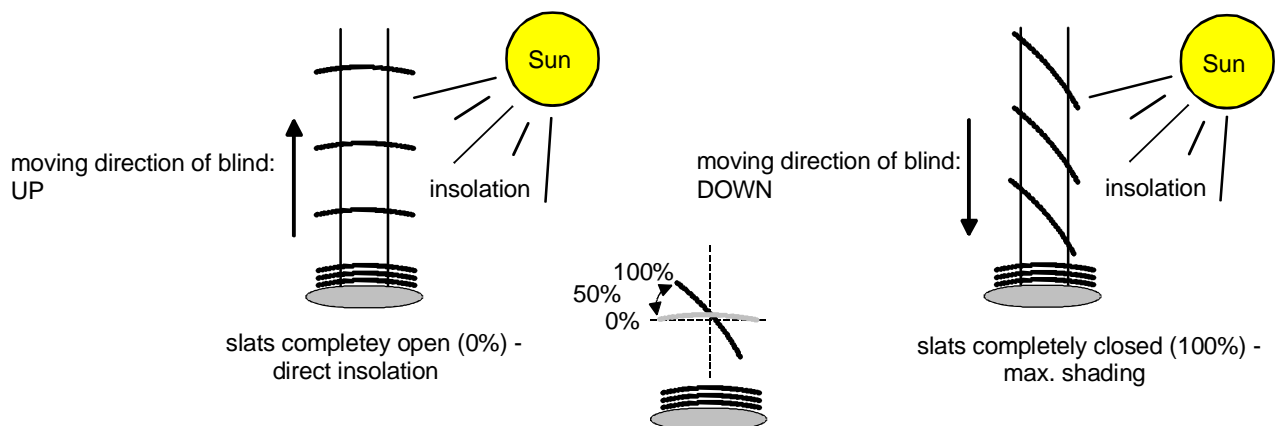

Fig. 25: Type 2 - slatted blinds with oblique and horizontal slat position

Presetting the slat moving time

The measurement of the slat moving time is described in detail in chapter "2.4 Commissioning".

- Set the parameter "Slat moving time" on parameter page "Ax – Times" (x = number of output) exactly to the value determined in the course of the commissioning procedure.
- ❗ The slat moving time must be shorter than the preset or learnt curtain travelling time.
- ❗ The parameterized or measured travelling time extension will also be taken into account when slats are moved into the completely open position (upward travel).

Determining and configuring the travelling time extension and the change-over time

When travelling upwards, blinds, shutters or awnings have a tendency of moving more slowly due to their own weight or to external physical influences (e.g. temperature, wind, etc.). The same applies to venting louvers where opening may take longer than closing.

For this reason, the switching/shutter actuator takes the parameterized travelling time extension into account when moving upwards or when opening louvers. The time extension is computed as a percentage of the difference of the travelling times in both directions.

The travelling time extension must be determined during commissioning separately for each output and entered into the ETS parameters. The measurement of the travelling time extension is described in detail in chapter "2.4 Commissioning".

Example showing the calculation of the travelling time extension:

- "Travelling time" previously determined and parameterized: $T_{OU} = 20$ seconds,
- Time determined for travel from lower to upper end position: $T_{UO} = 22$ seconds,
- Calculated supplementary travelling time: $T_{UO} - T_{OU} = 2$ seconds → 2 seconds out of 20 seconds are 10 %,
- Travelling time extension to be parameterized: 10 %

To protect the drive from irreparable damage, a fixed pause during travel direction change-over can be parameterized for each output. During the pause, no travel direction is active ("stop"). The necessary parameter value can normally be found in the technical documents of the drive motor used. The change-over time is accounted for in every state of operation of the actuator.

Presetting the travelling time extension

- Enter the determined travelling time extension (by rounding up the determined extension value) into the parameter "Travelling time extension for upward travel" on parameter page "Ax – General" (x = number of output).

Presetting the change-over time for travel direction changes

- Set the parameter "Change-over time for travel direction changes" on parameter page "Ax - Time Settings" (x = number of output) to the required change-over interval.
- ❗ When the actuator is delivered ex factory, the change-over time is generally preset to 1 s.

Computing the curtain height or the louver position

The switching/shutter actuator has a comfortable and accurate positioning function. The actuator calculates the current position of the connected blind, shutter, awning or louver whenever these elements are adjusted either by manual or bus control. The calculated position value is a measure of the height of the curtain or of the opening width of the venting louver (cf. Fig. 26).

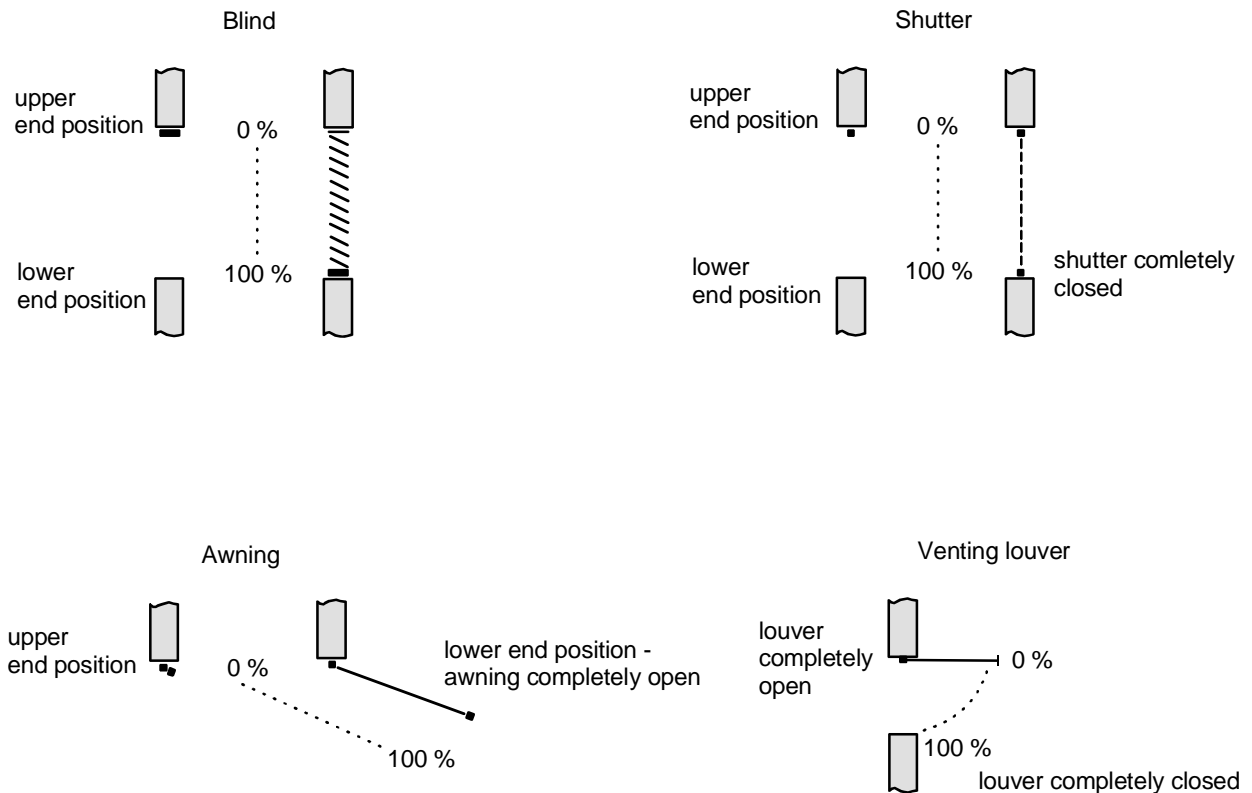

Fig. 26: Positions defined as a function of the type of movement

The switching/shutter actuator derives the positions from the parameterized travelling time since conventional drives do not provide feedback about their positions. Thus, the travelling time separately parameterized for each shutter output is the reference for all position approaches and of basic importance for the accuracy of the position calculations. For this reason, the travelling times should be determined with great accuracy in order to achieve the best possible positioning results.

For positioning purposes, the shutter actuator calculates the travelling time required as a function of the current position. Example 1...

The shutter connected to a certain output has an overall travelling time of 20 s. The shutter is in its upper end position (0 %). It is to be positioned at 25 %. The actuator calculates the travelling time required for approaching the desired position: $20 \text{ s} \cdot 0.25_{(25\%)} = 5 \text{ s}$. The output will then lower the shutter for 5 s and thus position the curtain at height of 25 %.

Example 2...

The shutter connected to a certain output has an overall travelling time of 20 s. The shutter is in the 25 % position. It is to be positioned at 75 %. The difference between the positions is 50 %. The actuator calculates the travelling time required for bridging the difference between the positions: $20 \text{ s} \cdot 0.5_{(50\%)} = 10 \text{ s}$. The output will then lower the shutter for 10 s and thus position the shutter curtain at height of 75 %.

For all upward travels, the travelling time extension parameterized or determined by end position detection will automatically be added to the travelling time calculated.

Example 3...

The shutter connected to a certain output has an overall travelling time of 20 s. The shutter is in the 75 % position. It is to be positioned at 25 %. The difference between the positions is 50 %. The actuator calculates the travelling time without extension required for bridging the difference between the positions:

$20 \text{ s} \cdot 0.5_{(50\%)} = 10 \text{ s}$. Taking the travelling time extension into account (e.g. 10 %), the actual raising time is: $10 \text{ s} \cdot ((100\% + 10\%_{(extension)}) : 100\%) = 10 \text{ s} \cdot 1,1 = 11 \text{ s}$.

The output will then raise the shutter for 11 s and thus position the shutter curtain at a height of 25 %. When the lower or upper end positions (0 % or 100 %) are approached, the travelling time is always 20 % longer than the overall travelling time.

Example 4...

The shutter connected to a certain output has an overall travelling time of 20 s. The shutter is in the 50 % position. It is to be positioned at 100 %. The difference between the positions is 50 %. The actuator calculates the travelling time required for bridging the difference between the positions: $20 \text{ s} \cdot 0.5_{(50\%)} = 10 \text{ s}$. As the travel is a travel into an end position, the actuator adds a fixed percentage corresponding to 20 % of the overall travelling time.

$10 \text{ s} + (20\% : 100\%) \cdot 20 \text{ s} = 14 \text{ s}$. The output will then lower the shutter for 14 s and thus position the shutter curtain safely at height of 100 %.

Example 5...

The shutter connected to a certain output has an overall travelling time of 20 s. The shutter is in the 50 % position. It is to be positioned at 0 %. The difference between the positions is 50 %. The actuator calculates the travelling time without extension required for bridging the difference between the positions:

$20 \text{ s} \cdot 0.5_{(50\%)} = 10 \text{ s}$. As the travel is a travel into an end position, the actuator adds a fixed percentage corresponding to 20 % of the overall travelling time. $10 \text{ s} + (20\% : 100\%) \cdot 20 \text{ s} = 14 \text{ s}$.

Taking the travelling time extension into account (e.g. 10 %), the actual raising time is: $14 \text{ s} \cdot ((100\% + 10\%_{(extension)}) : 100\%) = 14 \text{ s} \cdot 1,1 = 15,4 \text{ s}$. The output will then raise the shutter for 15.4 s and thus position the shutter curtain safely at a height of 0 %.

- i** The switching/shutter actuator executes position approaches only if a new position deviating from the current position is preset.
- i** The switching/shutter actuator stores the blind/shutter/awning or louver positions temporarily. The shutter actuator can approach newly preset blind/shutter/awning or louver positions only if the current positions are known. For this purpose, each output must be given the opportunity to synchronize itself whenever the supply voltage is switched on or after every ETS programming (physical address, application program, partial download). The synchronization is performed with the help of a reference travel (cf. "Reference travel").
- i** Position approaches in progress will be aborted in case of bus or mains voltage failure. In case of bus voltage failure, the parameterized behaviour will be executed. In case of mains failure, the drives will be stopped. Position approaches are also interrupted when the manual control mode is activated.

Calculating the slat position (only with blinds)

In the "blinds" mode of operation, the switching/shutter actuator always calculates the slat position so that the opening angle and thus the amount of light admitted into the room by the blind can be adjusted. A new position approach by a blind will always be followed by a positioning movement of the slats. Thus, the slat positions last selected will be tracked or readjusted to a new value if a position change has taken place.

In case of single-motor blind drive systems with working position, the slats will be readjusted directly by a change of the blind curtain height. For this reason, an adjustment of the slat position will always have an influence on the position of the blind itself (cf. Fig. 27).

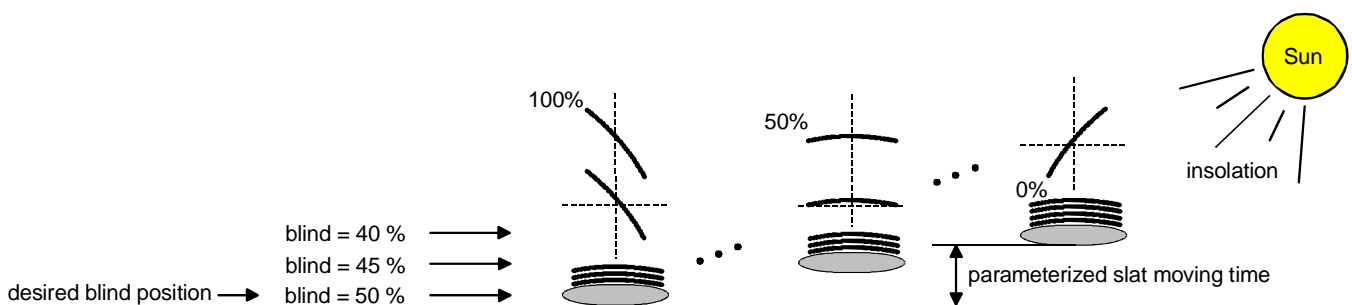

Fig. 27: Example of slat positioning affecting the position of the blind (typical of slat type 1; analogous reaction for type 2)

Since a preset slat position is to remain constant until the next change, the actuator will not change the height of the blind, if the calculated travelling time required for a change of position lies within the parameterized slat moving time.

Similarly, the actuator accounts for the ratio of the moving times of slat and blind and – in case of slat position changes – always recalculates the resulting blind position. If the position feedback objects are used (cf. "Position feedback"), the actuator transmits the blind positions changed by the adaptation also to the bus.

Example (cf. Fig. 27)...

The blind position is preset to 50 %. A change of the slat angle (100 %..0 %) initiates the calculation of a new blind position which is also tracked in the position feedback objects. If the actuator is to approach a new blind position of, let's say 47 % in this case, the actuator will not perform a travel movement as the calculated travelling time lies within the parameterized slat moving time and therefore coincides with the slat movement. A change of the blind position to 55 % in this case triggers a blind movement as the change does not lie within the slat movement (0 to 100 %).

For each positioning movement, the desired blind position is referred to a slat position of 100 %. In the event of a slat re-positioning movement (0 to 100 %), the actuator will therefore report a blind position below the desired position.

Exception: The desired blind position of 0 % (upper end position) is assigned to the slat position of 0 %. The re-adjustment of the slat position will result also in this case in a change of the blind height (brief downward travel). Only in this case will the actuator report back a blind position above the desired blind position (cf. Fig. 28). With slat type 1, the slats are generally horizontal when the blind is in its upper end position. For this reason, the calculated slat position with a slat of type 1 corresponds to the actual opening angle only after the first slat is completely extended (100%).

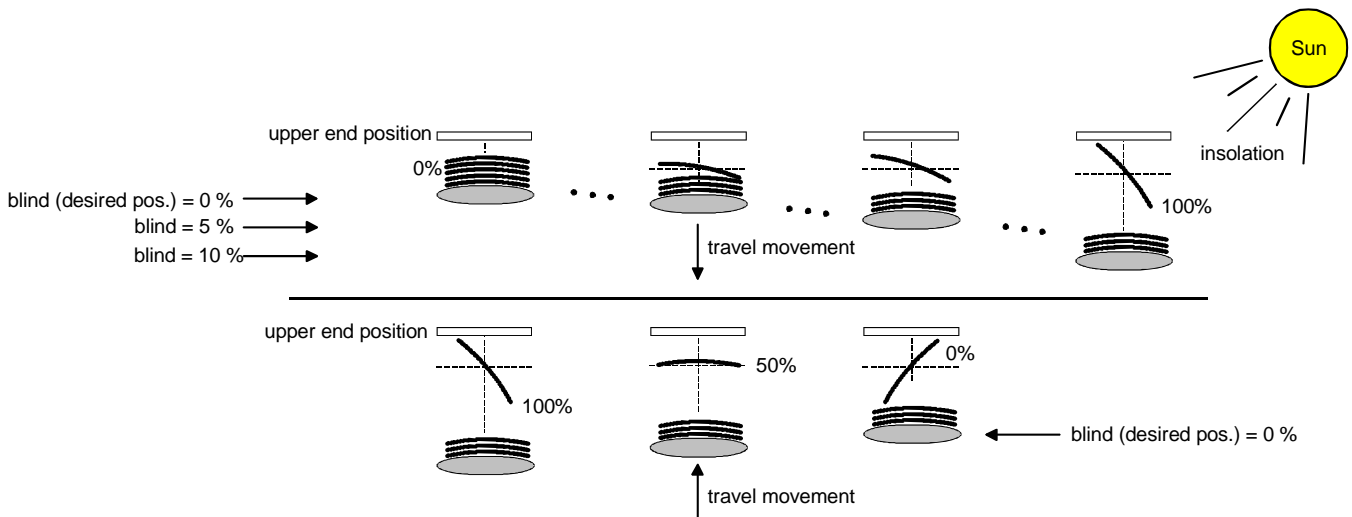

Fig. 28: Example of slat positioning with the blind in upper end position (typical of slat type 1)

Example (cf. Fig. 28)...

The blind position is preset to 0 %. After an extended travel movement, the blind is safely in the upper end position. A change of the slat angle (0 %...100 %) initiates the calculation of a new blind position which is also tracked in the position feedback objects. If the actuator is to approach a new blind position of, let's say 5 % in this case, the actuator will not perform a travel movement as the calculated travelling time lies within the parameterized slat moving time and therefore coincides with the slat movement. A change of the blind position to 15 % in this case triggers a blind movement as the change does not lie within the slat movement (0 to 100 %).

- ❶ The switching/shutter actuator executes slat position adjustments only if a new position deviating from the current slat position is preset.
- ❶ The switching/shutter actuator stores the slat positions temporarily. The actuator can approach newly preset slat positions only if the current position is known. For this purpose, each output must be given the opportunity to synchronize itself whenever the supply voltage is switched on or after every ETS programming (physical address, application program, partial download). The synchronization is performed with the help of a reference travel for the slat or the blind (cf. "Reference travel").
- ❶ A change of the blind height will always result in a change of the slat position. After reactivation of the supply voltage or after ETS programming, the actuator will in this case generally move the slats into the 100 % position, if no position has been preset for the slats.
- ❶ The smaller the ratio between slat moving time and blind travelling time, the more precise the position approaches and the less marked the influence of the slat angle adjustment on the height of the blind.

Reference travel

After ETS programming (physical address, application program, partial download) or after actuator supply voltage failure (bus and mains voltage) all current position data are unknown. Before the actuator can approach new positions after bus and mains voltage return or after programming, the positioning system must at first be calibrated. The positioning system can be calibrated by carrying out a reference travel.

A reference travel is the time required for a travel movement into the upper end position increased by 20 % and additionally by the parameterized travelling time extension (cf. Fig. 29). A reference travel is not retriggerable.

Reference travels can be executed by the following commands...

- an uninterrupted long-time travel (including also a terminated safety travel) into the upper end position activated via the corresponding communication object,
- an approach of the 0 % position,
- a manually controlled movement into the upper end position.

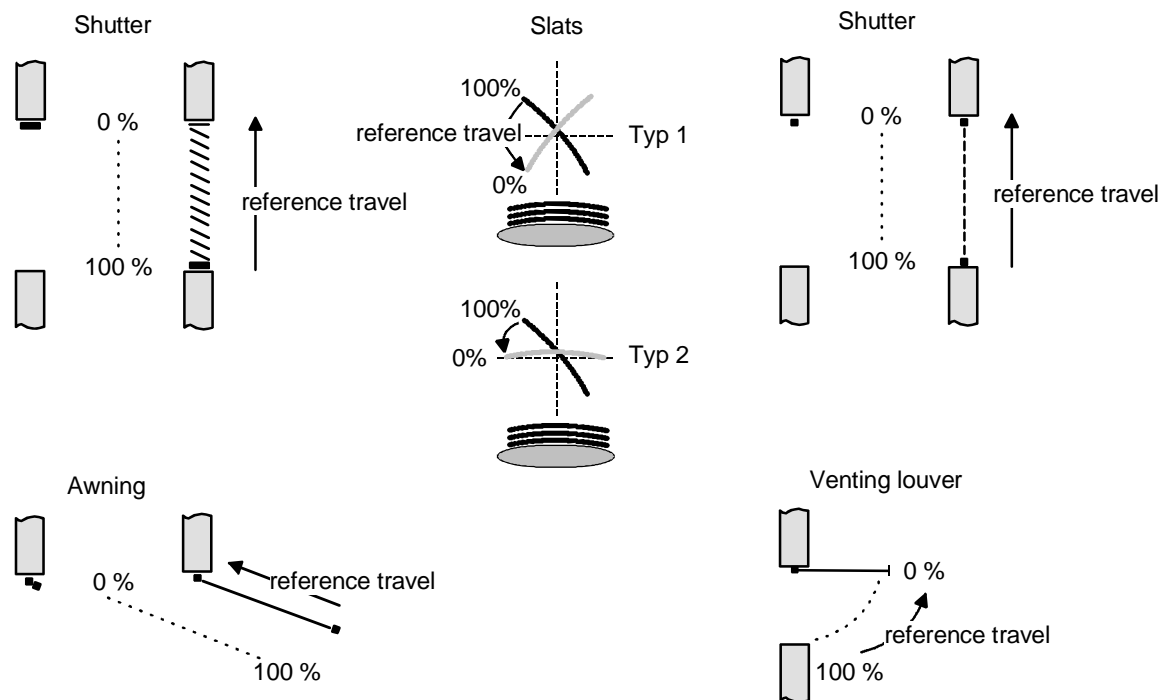

Fig. 29: Reference travel

In the event of slat positioning via the corresponding communication objects after bus and mains voltage return or after programming, a slat reference movement becomes necessary if the blind has not been moved beforehand in the up or down directions for at least the parameterized slat moving time. During a slat reference movement, the actuator always moves the slats for the parameterized slat moving time into the completely open position (0 %) and then to the desired position. The slat position is also considered as calibrated when the blind has been moved by a long-time command in the up or down direction during at least the parameterized slat moving time.

i A terminated reference travel of the blind will also calibrate the slat position.

- ❗ If the reference travel is interrupted for instance by a short-time operation, the position is still unknown as before.
- ❗ A long-time travel into the lower end position activated via the corresponding communication object also calibrates the reference position.
- ❗ When the automatic end position detection is used, the reference position is automatically calibrated in the course of the initial commissioning procedure (teaching of travelling times).
- ❗ With the sun protection function it is moreover possible to force the actuator to perform a reference travel before each sun protection travel even if the positions are known. Thus, it is ensured that in case of sun protection the parameterized sun protection position is always precisely approached even after repeated position approaches.
- ❗ Using the connected drives frequently for position approaches (for instance several times a day) can result after some time in positioning inaccuracies. These deviations from the nominal position are mostly due to external physical influences. To achieve accurate positioning in operation it is recommended to perform the reference travel at least once every day. This can be achieved for instance by a central raising command transmitted to the long-time object.

Presetting the position

The following ways of presetting positions can be distinguished...

- direct positioning via the positioning objects (direct operation)
- positioning by activating the sun protection function,
- positioning by the behaviour after bus voltage failure or bus or mains voltage return,
- positioning by a scene recall.

Positioning via the positioning objects:

Every blind, shutter, awning or louver can be positioned directly via the "Position..." object separate for each output. An independent positioning object exist equally for the slats. The position approached is always the position last received. The actuator shows no reaction, when the preset position value or the position to be approached is received several times in succession.

Like the operation via short-time, long-time or central objects, this form of control is also designated as 'direct operation'. Positioning via the objects therefore has the same priority.

A position approach effected by the communication objects can be interrupted at any time by a short-time, long-time or central command or by a scene recall.

The direct operation can be overridden by a function with a higher priority, e.g. manual control, forced position, safety or also sun protection (parameterizable).

The position telegrams must conform to the 1-byte data format as per KNX datapoint type 5.001 (scaling). The shutter actuator converts the value received (0...255) linearly into a position (0...100 %) (cf. table 2).

value received (0...255)	position derived from value (0...100 %)
0	0 % upper end position / slat or louver opened)
⋮	⋮ (all intermediate values rounded off to 1 % increments)
255	100 % lower end position / slat or louver closed)

Table 2: data format of positioning objects with conversion into percentage position values

It is possible that new positioning telegrams are being received while a position approach is in progress. In this case, the actuator immediately reverses the direction of travel, if the new position to be approached lies in the opposite direction.

If a slat positioning command is received during a running blind position approach, the actuator finishes first the blind position approach before positioning the slat. If a blind positioning command is received during a slat positioning movement, the actuator interrupts the slat positioning movement and approaches the new blind position. The slat positioning command last received will only be executed after the blind position is reached.

In case of blind position approaches, slat positioning will always be executed later. After switching on the power supply of the actuator or after programming with the ETS, it may be the case that the slat position is unknown, if no long-time command for the upward or downward travel with a duration of at least the parameterized slat moving time has been received or no slat positioning has taken place (no slat reference movement). In this case, the slat is moved during a blind position approach into the completely closed position (100 %). The slat position is then considered as calibrated.

i Optionally, the sun protection function offers the possibility of receiving the instruction of the curtain height, venting louver or slat position to be adopted during sunshine via separate communication objects and to preset these values variably. This form of variable position preset in the sun protection function is identical to presetting the positions via communication objects in the direct operation mode. The priority of the incoming telegrams in direct operation with the sun protection activated can be additionally parameterized.

Positioning by the sun protection function, the behaviour after bus voltage failure or bus or mains voltage return or by a scene recall

In case of the shutter actuator functions mentioned, the positions to be approached are parameterized directly in the ETS depending on the mode of operation. The position values can be specified between 0 % and 100 % in 1 % steps.

With blinds, the height of the blind is positioned first in these cases. The parameterized slat position is adjusted only thereafter.

i Important notes for all positioning movements: Using the connected drives frequently for position approaches (for instance several times a day) can result after some time in positioning inaccuracies. These deviations from the nominal position are mostly due to external physical influences. To achieve accurate positioning in operation it is recommended to perform the reference travel at least once every day. This can be achieved for instance by a central raising command transmitted to the long-time object.

Position feedback messages

In addition to presetting positions via positioning objects, the switching/shutter actuator can track the current positions values via separate feedback objects and also transmit them to the bus, if the bus voltage is on. Thus, the preset nominal position can be distinguished from the true actual position of the drives activated.

The following feedback telegrams can be preset for each output depending on the parameterized mode of operation.

- Feedback (1 byte) of the blind, shutter, awning or venting louver position,
- Feedback (1 byte) of the slat position (only with blinds).

The individual position feedback messages can be enabled in the ETS independent of one another and have communication objects of their own.

For each travel movement the actuator calculates the current position and tracks it in the position feedback objects. The positions are tracked and the feedback objects updated even when an output has been activated via short-time or long-time telegrams or by manual control on condition that the bus voltage is on.

The feedback objects are updated after the following events...

- at the end of a travel movement – including a slat positioning movement in a blind – when the drive stops and when the new position is reached,
- in case of a travel movement into an end position already at the time the end position is reached theoretically, i.e. before the 20 % extension and the travel time extension have elapsed.

The feedback objects are not updated, if the position last reported back has not changed after a movement (for instance, when the blind is repositioned, the unchanged slat position will not be reported back a second time).

The shutter actuator cannot calculate a feedback position, if the current position data after switch-on of the supply (bus voltage and mains voltage) or after ETS programming are still unknown. In these cases, the actuator must first perform a reference travel (cf. "Reference travel") so that the position can be calibrated. In case of unknown positions, the actuator automatically performs reference travels, if new positions are preset and if these positions are to be approached. As long as a position is unknown, the value of the feedback objects is "0".

Presetting position feedback for blind, shutter, awning or venting louver positions

The feedback functions can be enabled and programmed independently for each output. When feedback is enabled, the ETS adapts the parameter texts depending on the preset operating mode ("Blind position feedback", "Shutter/awning position feedback" or "Venting louver position feedback"). The status feedback can be used as an active signalling object or as a passive status object. As an active signalling object, the position feedback information is transmitted to the bus whenever a position value changes. As a passive status object, there is no telegram transmission after a change. In this case, the object value must be read out. The ETS automatically sets the object communication flags required for proper functioning.

In case of an actively transmitting signalling object, the current position can be transmitted to the bus after bus voltage return, if the position value differs from the one last transmitted. When the position data are known, the feedback telegram can in this case be transmitted with a time delay to reduce the bus load, with the delay being preset globally for all outputs in common (cf. "Delay after bus voltage return").

The feedback functions of an output must be enabled on parameter page "Ax – Enabled functions" (x = number of output). Only then are the parameters for the feedback functions visible.

- Set the parameter "Blind position feedback", "Shutter/awning position feedback" or "Venting louver position feedback" on parameter page "Ax – Feedbacks" to "feedback object is active signalling object"

The feedback object is enabled. The position value is transmitted as soon as it changes. No value will be actively transmitted, if the position is unknown.

- Set the parameter "Blind position feedback", "Shutter/awning position feedback" or "Venting louver position feedback" on parameter page "Ax – Feedbacks" to "feedback object is passive status object"

The feedback object is enabled. The position value will be transmitted in response only if the feedback object is read out from by the bus. If the position is unknown, a value of "0" will be reported back after readout.

The feedback function must be preset as actively transmitting function.

- If a time delay after bus voltage return should be necessary, the parameter "Time delay for feedback after bus voltage return" on parameter page "Ax – Feedbacks" must be set to "yes"

The position is then reported back with a time delay after bus voltage return. After the end of the time delay, the position last adjusted statically will be transmitted to the bus. No feedback telegram will be transmitted during a running delay, even if a position value changes during this delay.

Presetting the position feedback for slat positions (only with blinds)

The feedback functions for the slat positions can be enabled and programmed independently for each output. The slat position feedback can be used like the position feedback for the height of the blind as an active signalling object or as a passive status object.

In case of an actively transmitting signalling object, the current slat position can be transmitted to the bus after bus voltage return, if the position value differs from the one last transmitted. When the position data are known, the feedback telegram can in this case be transmitted with a time delay to reduce the bus load, with the delay being preset globally for all outputs in common (cf. "Delay after bus voltage return").

The feedback functions of an output must be enabled on parameter page "Ax – Enabled functions" (x = number of output). Only then are the parameters for the slat position feedback functions visible.

- Set the parameter "Slat position feedback" on parameter page "Ax – Feedbacks" to "feedback object is active signalling object".

The feedback object is enabled. The position value is transmitted as soon as it changes. No value will be actively transmitted, if the position is unknown.

- Set the parameter "Slat position feedback" on parameter page "Ax – Feedbacks" to "feedback object is passive status object".

The feedback object is enabled. The position value will be transmitted in response only if the feedback object is read out from by the bus. If the position is unknown, a value of "0" will be reported back after readout.

The feedback function must be preset as actively transmitting function.

- If a time delay after bus voltage return should be necessary, the parameter "Time delay for feedback after bus voltage return" on parameter page "Ax – Feedbacks" must be set to "yes".

The position is then reported back with a time delay after bus voltage return. After the end of the time delay, the position last adjusted statically will be transmitted to the bus. Although the feedback object concerned is updated during a running delay, no feedback telegram will, however, be actively transmitted during such delay, even if a position value changes during the delay.

i Behaviour of position feedback in case of voltage failure and voltage return:

When the bus voltage returns, with the mains voltage supply to the actuator being on, the current position data are always written into the feedback objects. The positions are transmitted to the bus also in those cases where the feedback objects are actively transmitting objects and where the position data differ from the data last reported back, for instance, as a result of manual control. If the position data are unknown, the feedback objects are initialized with "0" and are not transmitted to the bus.

Without mains voltage supply, the connected drives are not activated so that there is always no position feedback, even after return of the bus voltage.

In case of mains voltage return, the parameterized behaviour will be executed. The feedback objects are then updated provided the bus voltage is on.

- i** In case of blinds operation, any position change of the blind within the limits of the slat adjustment (0 to 100 %) does not launch a travel movement and therefore no change of the feedback position data either.

'Unknown position' feedback and travel movement

In addition to position data feedback, the switching/shutter actuator can also report back enlarged 1-bit status information messages and transmit them actively to the bus, if the bus voltage is on. The following status feedback messages can be separately preset for each output...

- invalid position feedback message,
- drive movement feedback message.

Invalid position feedback message:

After switch-on of the supply voltage (bus and mains voltage failure) or after programming with the ETS, all position data of an output are unknown. In this case – when the bus voltage is on – the switching/shutter actuator can update the feedback object "Invalid position" (object value "1") which will then signal that the object values of the 1-byte position feedback objects are invalid.

An invalid position feedback will be only be reversed (object value "0") after the position data for the blind, shutter, awning or venting louver have been calibrated by means of a reference travel. The calibration of the slat position in a blind alone will not result in the reversal of an 'invalid position' status message.

As an option, the object value of the status feedback message can be actively transmitted to the bus in case of a value change.

Travel movement feedback message:

The switching/shutter actuator can report back via a separate 1-bit communication object per output whether the connected drive is moving, i.e. whether the output is supplying current for any of the travel directions. The feedback object has a value of "1" when current is flowing from the output to the drive. Likewise, a "0" is written into the object if the output concerned remains in a stop position. In this case, the operation by which the output was activated (short-time or long-time operation, positioning, manual control, etc.) is of no importance.

As an option, the object value of the status feedback message can be actively transmitted to the bus in case of a value change.

A mains voltage failure in the shutter actuator always results in a "0" being written into the "Travel movement" feedback object. Moreover, the feedback status is derived exclusively from the relay state of the actuator. This means that if a drive is blocked or already in its end position, the value reported back does not correspond to the actual state of the travel movement.

Presetting an 'invalid position' feedback

The feedback for an invalid position can be enabled and programmed independently for each output. When feedback is enabled, the ETS adapts the parameter texts depending on the preset operating mode ("Invalid blind position feedback", "Invalid shutter/awning position feedback" or "Invalid venting louver position feedback").

The status feedback can be used as an active signalling object or as a passive status object. As an active signalling object, the status feedback information is transmitted to the bus whenever a position value changes. As a passive status object, there is no telegram transmission after a change. In this case, the object value must be read out. The ETS automatically sets the object communication flags required for proper functioning.

If the object is an actively transmitting signalling object, the feedback telegram can be transmitted after bus voltage return with a time delay to reduce the bus load, with the delay being preset globally for all outputs in common (cf. "Delay after bus voltage return").

The feedback functions of an output must be enabled on parameter page "Ax – Enabled functions" (x = number of output). Only then are the parameters for the feedback functions visible.

- Set the parameter "Invalid blind position feedback", "Invalid shutter/awning position feedback" or "invalid venting louver position feedback" on parameter page "Ax – Feedbacks" to "feedback object is active signalling object"

The feedback object is enabled. A telegram is transmitted as soon as there is a change (e.g. after ETS programming, after switch-on of the supply voltage or after a reference travel).

- Set the parameter "Invalid blind position feedback", "Invalid shutter/awning position feedback" or "invalid venting louver position feedback" on parameter page "Ax – Feedbacks" to "feedback object is passive status object".

The feedback object is enabled. A telegram will be transmitted in response only if the feedback object is read out by the bus.

The feedback function must be preset as actively transmitting function.

- If a time delay after bus voltage return should be necessary, the parameter "Time delay for feedback after bus voltage return" on parameter page "Ax – Feedbacks" must be set to "yes".

An invalid position reported back with a time delay after bus voltage return. After the end of the time delay, the object value state last adjusted will be transmitted to the bus. No feedback telegram will be transmitted during a running delay. This is also the case if a position value becomes known, for instance, after a reference travel.

- i** Automatic transmission after bus voltage return will take place only if an internal change of the object state has occurred (caused, for instance, by a reference travel during manual control).

Presetting the travel movement feedback

The feedback messages can be enabled and programmed separately for each output. The status feedback can be used as an active signalling object or as a passive status object. As an active signalling object, the status feedback information is transmitted to the bus whenever the object value changes. As a passive status object, there is no telegram transmission after a change. In this case, the object value must be read out. The ETS automatically sets the object communication flags required for proper functioning.

With an active signalling object, the feedback telegram can be transmitted after bus voltage return with a time delay to reduce the bus load, with the delay being preset globally for all outputs in common (cf. "Delay after bus voltage return").

The feedback functions of an output must be enabled on parameter page "Ax – Enabled functions" (x = number of output). Only then are the parameters for the feedback functions visible.

- Set the parameter "Travel movement feedback" on parameter page "Ax – Feedbacks" to "feedback object is active signalling object".
The feedback object is enabled. A telegram is transmitted when the connected drive starts moving or stops.
- Set the parameter "Travel movement feedback" on parameter page "Ax – Feedbacks" to "feedback object is passive status object".
The feedback object is enabled. A telegram representing the current travel movement will be transmitted in response only if the feedback object is read out by the bus.

The feedback function must be preset as actively transmitting function.

- If a time delay after bus voltage return should be necessary, the parameter "Time delay for feedback after bus voltage return" on parameter page "Ax – Feedbacks" must be set to "yes"
A travel movement feedback telegram is transmitted with a time delay after bus voltage return, for instance, when the drive is set in motion as a result of the preset behaviour after bus voltage return. After the end of the time delay, the object value state last adjusted will be transmitted to the bus. No feedback telegram is transmitted during a running delay. This is also the case if the drive stops or starts moving during this delay.

i Automatic transmission after bus voltage return will take place only if the drive starts moving on return of bus voltage or if there has been a change of the travel movement caused by the bus failure.

Safety function

The switching/shutter actuator can handle up to five different safety functions: 3 x wind alarm, 1 x rain alarm, 1 x frost alarm. Each safety function has a communication object of its own so that the functions can be activated or deactivated independently of one another. The safety functions are programmed and configured for all outputs in shutter mode together (cf. chapter "4.2.4.1 Description of channel-independent functions – Safety functions").

The different outputs in shutter mode of the actuator can be separately assigned to all or to individual safety functions. Only assigned outputs react to a change of state of the safety objects. The reactions at the beginning of an alarm ("1" telegram) can be parameterized for each alarm separately whereas the reaction at the end of an alarm ("0" telegram) can be parameterized for all alarms in common (cf. Fig. 30).

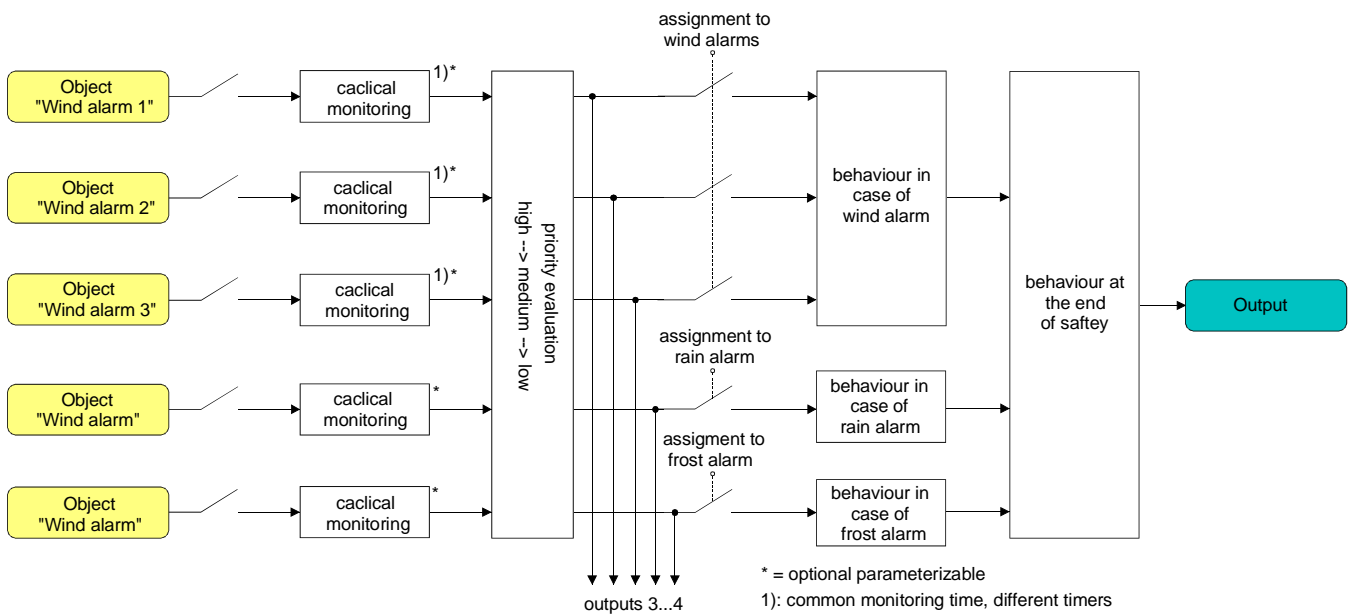

Fig. 30: Function diagram of channel-oriented safety functions

An output can be assigned independently to the wind alarms, the rain alarm and the frost alarm. If an output is associated with several alarms, the preset priority decides which of the alarms will prevail and be executed. An alarm with a higher priority overrides the alarms with the lower priorities. When safety alarm with the higher priority has ended, the safety alarm with the lower priority is executed on condition that it is active.

The order of priority of the wind alarms with respect to the frost alarm or to the rain alarm can be parameterized independent of the channel on the "Safety" parameter page. The three wind alarms have the same priority with respect to one another (logic OR). The last telegram update to the wind alarm objects decides which of the wind alarms will be executed. The wind alarm is completely deactivated only after all three objects are inactive ("0").

An output in the active safety alarm state is locked, i.e. the control of the output concerned via the bus by direct operation (short-time, long-time telegram, scenes, positioning, central) or by a sun protection function is prevented. Only a forced position and a manual control locally on the device itself have a higher priority so that these functions may override a safety interlock. At the end of a forced position or of a manual control, the safety reaction is re-executed if an assigned safety alarm is still active.

Assigning safety alarms

The individual safety alarms can be assigned separately to each output. The channels are assigned on parameter page "Ax – Safety" (x = number of output).

The safety functions must be globally enabled on the "Shutter outputs safety" parameter page before the output assignments are configured.

The safety function for an output must be enabled on parameter page "Ax – Enabled functions (x = number of output). Only then are the channel-related parameters for the safety function visible.

- If an assignment to the wind alarms is necessary, set the parameter "Assignment to wind alarms" to the wind alarm or the wind alarms required.

The output is assigned to the specified wind alarms.

- If an assignment to the rain alarm is necessary, set the parameter "Assignment to rain alarm" to "yes".

The output is assigned to the rain alarm.

- If an assignment to the frost alarm is necessary, set the parameter "Assignment to frost alarm" to "yes".

The output is assigned to the frost alarm.

i If an output is assigned to an alarm which is not globally enabled, the assignment is without effect.

i Important information about the activation or deactivation of a safety alarm, about the presetting of the priority and about cyclical monitoring can be found in chapter "4.2.4.1 Channel-independent functional description – Safety functions".

Presetting the behaviour at the beginning of a safety alarm

The behaviour of an output at the beginning of a safety alarm can be parameterized separately for each alarm (wind alarms in common, rain and frost alarms separately). The alarm behaviour is preset on parameter page "Ax – Safety" (x = number of output). At the beginning of a safety alarm, the actuator locks the outputs concerned so that controlling via the bus by direct operation or by a sun protection function is prevented.

Depending on the selected mode of operation, the ETS adapts the designations of the parameter settings ("raising" ↔ "opening the louver" / "lowering" ↔ "closing the louver").

The safety functions must be globally enabled on the "Shutter outputs safety" parameter page.

The safety function for an output must be enabled on parameter page "Ax – Enabled functions (x = number of output). Only then are the channel-related parameters for the safety function visible.

The behaviour in case of a safety alarm can only be adjusted, if the output concerned has been assigned to the corresponding alarm. Since there is no difference between the alarm-dependent parameterizations, the selection of the parameters is described below only once.

- Set the parameter "Behaviour in case of ..." to "no reaction"

At the beginning of the alarm, the output is locked and the relay of the output shows no reaction. Any travel movements still in progress at this instant will still be completely finished.

- Set the parameter "Behaviour in case of ..." to "raising" or "opening the louver".
The actuator raises the curtain or opens the venting louver at the beginning of the alarm and locks the output thereafter.
 - Set the parameter "Behaviour in case of ..." to "lowering" or "closing the louver".
The actuator lowers the curtain or closes the venting louver at the beginning of the alarm and locks the output thereafter.
 - Set the parameter "Behaviour in case of ..." to "stop"
At the beginning of the alarm, the actuator switches the relays of the output to "stop" and locks the output. A travel movement, if any, will be interrupted.
- ❗ The safety travel time required by an output to move the drive into the end positions is determined by the "Travel time" parameter on parameter page "Ax - Time settings". Like the long-time operation, a safety travel is derived from the travel time. Downward travel: travel time + 20 %; Upward travel: travel time + 20 % + parameterized or taught-in travel time extension. Safety travels are not retriggerable.
- ❗ Slats of blinds are not repositioned at the end of safety travels into end positions.

Presetting the behaviour at the end of all safety alarms

The switching/shutter actuator ends the safety interlock of an output only after all safety alarms assigned to the output have become inactive. Thereafter, the output concerned shows the parameterized "Behaviour at the end of safety". This behaviour is parameterized in common for all alarms on parameter page "Ax – Safety" (x = number of output).

Depending on the selected mode of operation, the ETS adapts the designations of the parameter settings ("raising" ↔ "opening the louver" / "lowering" ↔ "closing the louver").

The safety functions must be globally enabled on the "Shutter outputs safety" parameter page.

The safety function for an output must be enabled on parameter page "Ax – Enabled functions (x = number of output)". Only then are the channel-related parameters for the safety function visible.

- Set the parameter "Behaviour at the end of safety" to "no reaction"
At the end of all safety alarms, the output is released and the relay of the output shows no reaction. Any travel movements still in progress at this instant will still be finished.
- Set the parameter "Behaviour at the end of safety" to "raising" or "opening the louver".
The actuator releases the output at the end of all safety alarms and raises the curtain or opens the venting louver.
- Set the parameter "Behaviour at the end of safety" to "lowering" or "closing the louver".
The actuator releases the output at the end of all safety alarms and lowers or closes the venting louver.
- Set the parameter "Behaviour at the end of safety" to "stop"
At the end of all safety alarms, the output is released and the actuator switches the relays of the output to "stop". A travel movement in progress, if any, will be interrupted.

- Set the parameter "Behaviour at the end of safety" to "tracking the position".
At the end of all safety alarms, the output will be set to the state last adjusted statically before the safety function or to the state tracked and internally stored during the safety function. The position objects, the long-time object and the scene function are tracked.
- ❏ Parameter setting "Position tracking": The switching/shutter actuator can track absolute positions after safety release (position telegram, scene value) only if the position data are known and if the positions have been predefined. In all other cases, no reaction takes place on release of safety. Position data can be tracked, if the output was in a defined position before the safety function or if a new position telegram was received via the position objects during the safety interlock. In the latter case, a reference travel will be executed when the safety function is enabled, if the position before or during the safety interlock was unknown.
Known slat positions will also be tracked as described. This is also the case, when the height of the blind is unknown.
Long-time travel movements (travels without position preset) will, however, always be tracked.
- ❏ The preset "Behaviour at the end of safety" will only be executed, if the output passes over to direct operation at the end of all safety alarms. If a sun protection function is activated (independent of the preset priority with respect to direct operation), it will be also executed.

Sun protection function

Each output in shutter mode of the switching/shutter actuator can be separately configured for the execution of a sun protection function. Sun protection is generally realized with blinds, shutters or awnings and offers an intelligent method of shading rooms, terraces or balconies during sunshine depending on the altitude of the sun in the sky and on the intensity of the sunlight (cf. Fig. 31).

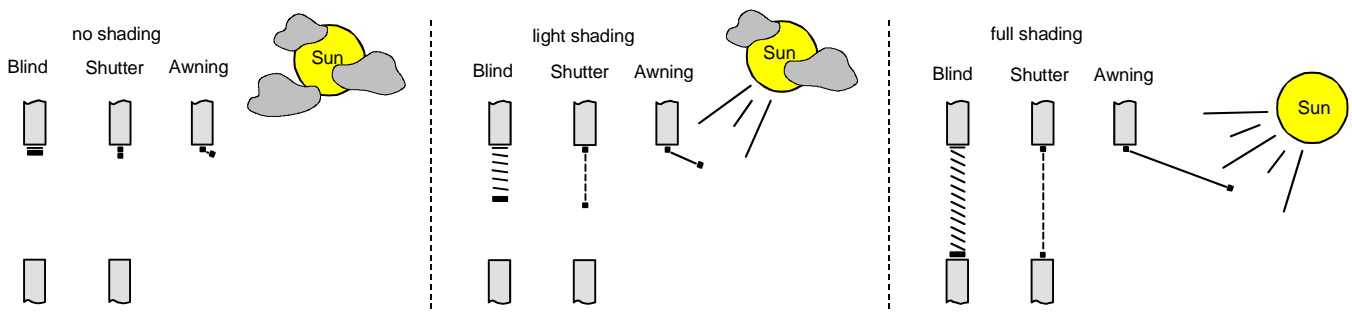

Fig. 31: Sun protection principles (example)

The sun protection functions of the switching/shutter actuator can be adapted many different applications.

In simple applications as, for instance, in case of direction-dependent measurement of the sun's intensity by means of a brightness sensor, the curtains controlled can be closed partly or completely to prevent being disturbed by direct sunlight. In these applications, the sun protection function merely evaluates the 1-bit sun signal from the brightness or a similar sensor (e.g. weather station with limit value monitoring) and makes a drive open or close the controlled curtains by moving them into fixed parameterized positions or into variable positions preset via the bus.

In extended applications – for instance where the degree of shading is controlled by weather stations evaluating additionally the sun angle as a function of astro coordinates and presetting the blind and also the slat positions dynamically – the sun protection function can be supplemented by an automatic control system.

Already simple sun protection applications are sufficient to permit a fixed or variable re-adjustment of the positions of blind slats for adapting the curtain to individual shading requirements. For such purpose, it is possible to preset a statical slat offset in the ETS parameters, for instance, for adapting the reflection of sunlight depending on the building situation, or additionally, a dynamical slat offset via a bus communication object, for instance, for manual re-adjustment of the slat opening by persons in the room or otherwise by a central building services control system.

In all cases, the priority between an incoming sunshine or automatic telegram and the direct operation of an output (short-time, long-time telegram, scenes, positioning, central) is also presettable in the ETS. This way, a sun protection position can, for instance, be influenced by a 'manual' operation of a touch sensor in the room and the sun protection function be interrupted. Alternatively, the protection function cannot be interrupted by a direct operation. i.e. the output is interlocked.

A sun protection function can be overridden by a safety function, a forced position (only in ETS3.0d and onwards) or also by a manual control locally on the device itself as these functions of the actuator invariably have a higher priority. At the end of one of the mentioned functions with a higher priority, the same reaction as the one at the beginning of sun protection will be re-executed, if the sun protection function is still active at this time.

Shading against sunlight is activated and deactivated via the 1-bit communication object "Sunshine / shading facade ". The polarity of this object can be selected in the ETS. The sun protection is activated as soon as "sunshine" is signalled to the object depending on the preset polarity. After ETS programming or after switch-on of the supply voltage, the object must at first have data written into it by the bus also in case of inverted polarity before the sun protection can be activated.

A newly received object value (sun / beginning of shading or sun / end of shading) can optionally be evaluated with a time delay. This feature permits suppressing brief increases of brightness caused, for instance, by light clouds or by a thunderstorm.

An update (from activated to activated) of the "Sunshine / shading facade" object causes the sun protection to be reactivated, if it had been influenced and possibly been re-enabled beforehand by a direct operation in acc. with the preset priority.

The reaction of a specific output at the beginning of shading can be preset in the ETS. This setting permits approaching fixed parameterized positions or positions preset via the bus and thus variable. Variable positions for sun protection purposes can be preset, for instance, by means of touch sensors or visualizations. In addition, it is possible in case of a defined sun protection positioning movement to have a reference travel executed by forced control. This ensures that identical curtain positions are approached synchronously by different outputs in case of a sun protection positioning movement. The reaction at the end of a shading task can be preset as well. In this situation, the curtain can pass into an end position, be stopped or shown no special reaction. Tracking of positions is possible as well.

By means of a priority setting in the ETS parameters it can be specified whether the sun protection function can be influenced by operation or whether the corresponding output is locked by a telegram "Sunshine / shading facade " in the sun protection position. Basically, the "Manual control", "Forced position" and "Safety" functions have a higher priority so that these functions can override, but not terminate a sun protection. Thus, the sun protection function is re-executed at the end of a function with a higher priority, if the object "Sunshine / shading facade" continues to signal the presence of sunshine.

i After an ETS programming operation, the sun protection function is always deactivated. An activated sun protection (independent of the selected priority with respect to direct operation) remains active even after a bus voltage failure as long as the mains voltage supply is still on. The sun protection reaction last executed will therefore be executed again at the end of a temporary or permanent manual control (if enabled in case of bus failure), even if there is no bus voltage.

Fig. 32 is a schematic diagram showing the principle of the simple sun protection and an example of how sensor components can be integrated into a sun protection configuration.

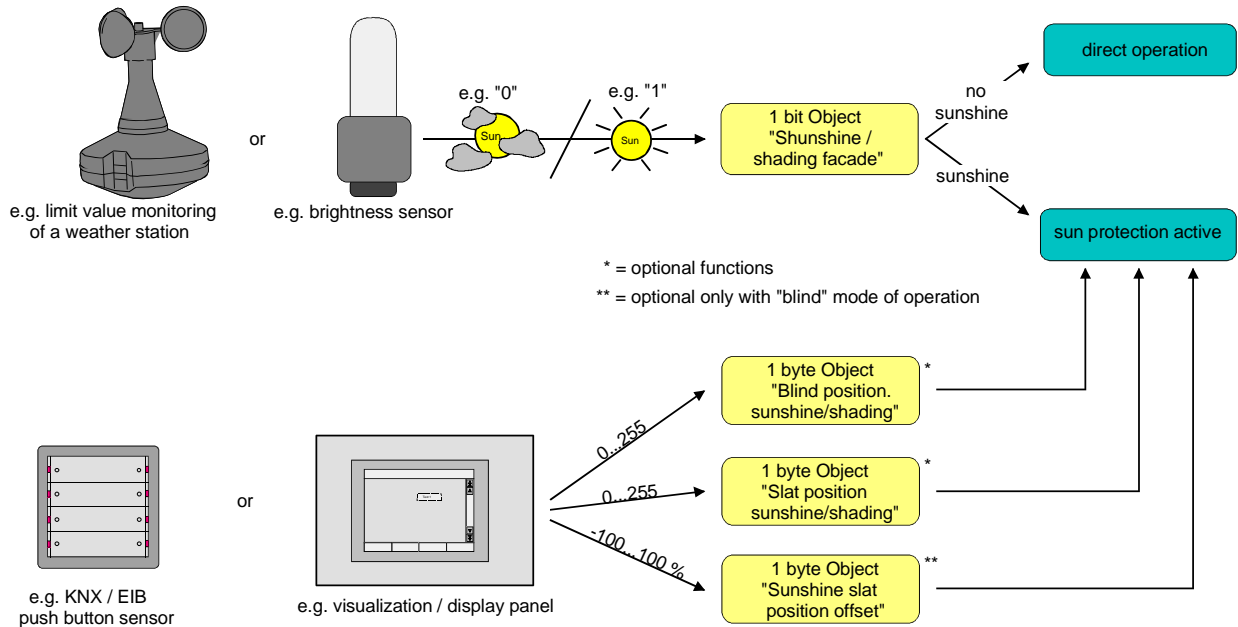

Fig. 32: Schematic diagram illustrating the sun protection configuration

Fig. 33 shows all possible functions of the sun protection in a function diagram. For reasons of clarity, the functions with a higher priority (manual control, forced position, safety function) are not shown in the diagram.

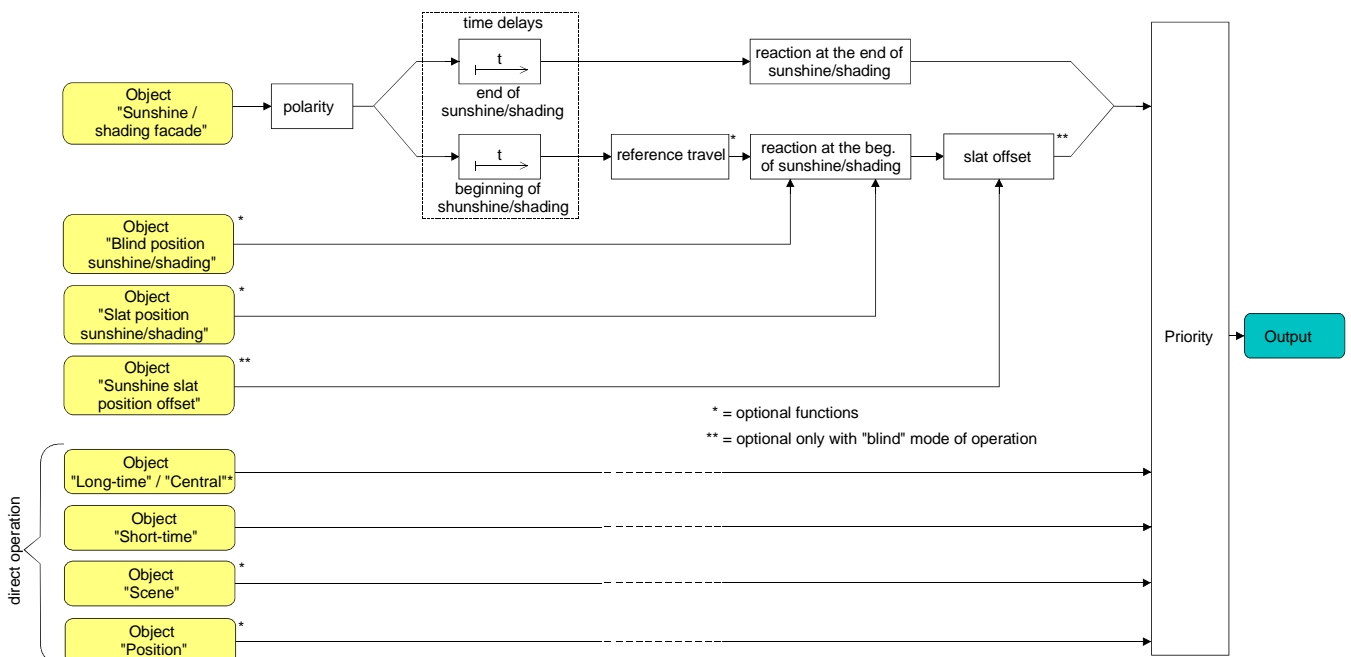

Fig. 33: Function diagram illustrating the sun protection

Presetting the priority of sun protection

The priority of the sun protection function can be set separately for each output. In the simple sun protection, the priority relations between the "Sunshine / shading facade" object and the objects of direct operation (short-time, long-time, central or position telegram, scene recall) must be configured. For the sun protection parameters to be visible, the sun protection function must be enabled on parameter page "Ax – Enabled functions (x = number of output).

- Set the parameter "Priority of sun protection with respect to direct operation" on parameter page "Ax - Sun protection" to "same priority".

The sun protection mode can be overridden at any time by direct operation. In the same way, the sun protection overrides the direct operation, when a new "sunshine" telegram is received via the "Sunshine / shading facade" object and when a parameterized time delay, if any, has elapsed. If the sun protection function is overridden by a direct operation, the preset behaviour "Reaction at the end of sunshine / shading" will not be executed.

- Set the parameter "Priority of sun protection with respect to direct operation" on parameter page "Ax - Sun protection" to "higher priority".

An active sun protection will override a direct operation. The sun protection mode can therefore not be interrupted by a direct operation. Direct operation will be possible again only after the sun protection function is terminated.

- Set the parameter "Priority of sun protection with respect to direct operation" on parameter page "Ax - Sun protection" to "lower priority".

A direct operation can at any time override the sun protection mode. If the sun protection function is overridden by a direct operation, the preset behaviour "Reaction at the end of sunshine / shading" will not be executed. The sun protection function can only be reactivated after an enabling movement controlled by a direct operation has been effected and after a new "sunshine" telegram has been received via the "Sunshine / shading facade" object. If the enabling movement has not yet occurred, any attempt to activate the sun protection will be disregarded.

Enabling movement:

An enabling movement is an accomplished long-time travel movement into the upper end position which has been initiated by the objects "Long-time operation" or "Central travel control" A manual control, an upward travel movement after bus voltage failure or bus voltage return, a position approach to "0 %" or an upward travel movement after releasing enabling of forced-position or safety functions have no enabling effect.

The sun protection is not enabled if the enabling movement has been interrupted. The sun protection function will be also be interlocked, if the output has been re-adjusted again by a direct operation after an accomplished enabling movement.

After an ETS programming operation or after switch-on of the supply voltage (bus and mains voltage) the sun protection function is generally enabled.

- ❗ Manual local operation on the device itself, the forced position function and the safety functions have a fixed priority higher than that of the sun protection. The sun protection is overridden – but not terminated – by a function with a higher priority. After the end of the function with the higher priority the reaction at the beginning of sun protection will therefore be executed again, if the sun protection is still active at this time.
- ❗ With the settings "same priority" or "lower priority", the sun protection can be overridden by a direct operation only if the direct control action can be executed at once. A direct operation will therefore not be able to override the sun protection during a manual control locally on the device, an active forced position function or an active safety function.

- ❶ Parameter setting "same priority" or "lower priority": A variable preset of curtain and slat positions or of a slat offset via the bus at the beginning of sunshine / shading shows no reaction at the output, if the sun protection was overridden by direct operation. However, the position data or offsets received are stored internally so that the new positions will be approached on reactivation of the sun protection.

Presetting the polarity of the "Sunshine / shading facade" object

The telegram polarity of the "Sunshine / shading facade" object can be preset separately for each output. This means that an adaptation to the signals from existing sensors or weather stations is possible in the simple and also in the enlarged sun protection mode.

For the sun protection parameters to be visible, the sun protection function must be enabled on parameter page "Ax – Enabled functions (x = number of output).

- Set the parameter "Polarity of 'Sunshine / shading facade' object" on parameter page "Ax - Sun protection" to the required telegram polarity.

The sunshine signal is evaluated in accordance with the preset priority.

- ❶ An update (from activated to activated) of the "Sunshine / shading facade" object causes the sun protection to be reactivated, if it had been influenced and possibly been re-enabled beforehand by a direct operation in acc. with the preset priority.

Presetting a time delay for beginning and end of sunshine / shading

The telegram received via the object "Sunshine / shading facade" for activation or deactivation of shading (depending on polarity) can be evaluated with a time delay separately for each output. The preset delay times are always evaluated in the simple as well as in the enlarged sun protection mode.

For the sun protection parameters to be visible, the sun protection function must be enabled on parameter page "Ax – Enabled functions (x = number of output).

- Set the parameter "Time delay at the beginning of sunshine / shading" on parameter page "Ax – Beginning of sun protection" to the required delay time.

The telegram for activation of the sun protection will be evaluated with a delay corresponding to the setting.

- Set the parameter "Time delay at the end of sunshine / shading" to the required delay time.

The telegram for deactivation of the sun protection will be evaluated with a delay corresponding to the setting.

- ❶ A setting of "0" in the parameters deactivates the respective delay time. In this case, the state of the sunshine signal is evaluated immediately.

- ❶ An update (from activated to activated) of the "Sunshine / shading facade" object causes the sun protection to be reactivated in consideration of the delay time, if the sun protection had been influenced or aborted beforehand by a direct operation because of the same or a lower priority.

Presetting the reaction at the beginning of sunshine / shading

The behaviour of the output at the beginning of sunshine / shading – if applicable, after the end of the delay time – can be configured in the ETS separately for each output. In the sun protection mode, the behaviour will be executed, when the sun protection function is activated after receiving a new sunshine signal. The reaction will not be executed if a function with a higher priority is active at the time the new sunshine signal is received.

The reaction at the beginning of sunshine / shading is preset on parameter page "Ax – Beginning of sun protection" (x = number of output). Depending on the selected mode of operation, the ETS adapts the designations of the parameter settings ("raising" ↔ "opening the louver" / "lowering" ↔ "closing the louver"). The ETS equally adapts the parameter selection depending on the preset mode of operation.

For the sun protection parameters to be visible, the sun protection function must be enabled on parameter page "Ax – Enabled functions (x = number of output).

- Set the parameter "Reaction at the beginning of sunshine / shading" to "no reaction".
At the beginning of shading, the output switches over to sun protection while the relays of the output show no reaction. Any travel movements still in progress at this instant will still be finished.
 - Set the parameter "Reaction at the beginning of sunshine / shading" to "raising" or "opening the louver".
At the beginning of shading, the actuator raises the curtain or opens the venting louver.
 - Set the parameter "Reaction at the beginning of sunshine / shading" to "lowering" or "closing the louver".
At the beginning of shading, the actuator lowers the curtain or closes the venting louver.
 - Set the parameter "Reaction at the beginning of sunshine / shading" to "stop".
At the beginning of shading, the actuator switches the relays of the output to the "stop" position. A travel movement in progress, if any, will be interrupted.
 - Set the parameter "Reaction at the beginning of sunshine / shading" to "internal scene recall". The number of the scene to be recalled must be specified in the parameter "Scene number (1...8)".
At the beginning of shading, the shutter actuator recalls the position value preset in the scene configuration for the output concerned. This is not a scene recall as in direct operation, but only an approach to the corresponding scene position value.
 - Set the parameter "Reaction at the beginning of sunshine / shading" to "fixed position".
At the beginning of shading, the shutter actuator recalls a fixed position value for the output concerned.
- i** In the "Blinds" mode of operation, the setting "fixed position" can be selected separately for the height of the blind and for the slat position. For this reason, the ETS adapts the parameter selection and enlarges the setting options in this mode of operation.

- "Fixed position" only: Set the parameter "Fixed position of blind", "Fixed position of shutter/awning" or "Fixed position of venting louver" to "as specified by parameter". Thereafter, set the parameter "Position of blind (0...100%)", "Position of shutter/awning (0...100%)" or "Position of venting louver (0...100%)" to the desired position.
At the beginning of shading, the output invariably approaches the parameterized position value.
 - "Fixed position" only: Set the parameter "Fixed position of blind", "Fixed position of shutter/awning" or "Fixed position of venting louver" to "no change of current position".
At the beginning of shading, the last adjusted height of the blind, of the shutter, of the awning or of the venting louver will be maintained.
 - "Fixed position" and mode of operation = "blind" only. Set the parameter "Fixed slat position (0...100%)" to the desired position value.
At the beginning of shading, the output invariably moves the slats to the parameterized position after the height of the blind has been adjusted.
 - Set the parameter "Reaction at the beginning of sunshine / shading" to "variable position".
At the beginning of shading, the shutter actuator recalls the variable position value for the output concerned. The variable position of the height of the blind, of the shutter, awning or venting louver position is preset via the separate communication object "Sunsh./shading ... position" (in the mode "Blind" for the slats also via the separate object "Sunsh./shading slat position").
- ❗ In the "Blind" mode of operation, the "variable position" setting can be selected separately for the height of the blind and for the slat position. For this reason, the ETS adapts the parameter selection and enlarges the setting options in this mode of operation.
- ❗ The behaviour preset in this parameter will only be executed, if no function with a higher priority (e.g. safety) is activated at the time of shading.
- ❗ "Internal scene recall" setting: For this setting, the scene function of the output must be enabled in the ETS. Otherwise, the positions approached at the beginning of sunshine/shading are undefined positions. The scene position values stored in the actuator by a scene storage function will be approached as well. A delay configured for scene recalls has no influence on the recall of the scene value by the sun protection function.
- ❗ "Variable position" setting: After an ETS programming operation or after switch-on of the supply voltage, the objects "Sunsh./shading ... position" and "Sunsh./shading slat position" must receive position values from the bus. Otherwise, the actuator makes no positioning attempts at the beginning of sunshine/shading as it has no valid position data.
When the actuator is in operation, the position data can be updated at any time via the bus even if the sun protection is active (e.g. by a weather station for the purpose of sun position tracking). The shutter actuator will then immediately approach the newly received positions if the sun protection is active. If a function with a higher priority is active, the actuator stores the newly received position values and approaches them during a later shading operation.
The position data last received are not lost in a bus voltage failure (mains voltage on).

Presetting a forced reference travel in the sun protection mode

If needed, a reference travel can be executed by forced-control in the sun protection mode at the beginning of a shading cycle, if fixed or variable position values or scene positions are to be approached. The execution of a reference travel by forced control at the beginning of shading can be used in a sun protection positioning operation to ensure that the curtains or slats are moved synchronously by different outputs to identical positions (e.g. in a long row of windows). Without the execution of reference travel by forced control, there might otherwise be positioning inaccuracies with a negative effect on the overall appearance of a building facade with the blinds let down.

A reference travel by forced control will always be executed in the sun protection mode, when the beginning of shading is signalled for the first time via the "Sunshine/shading facade" object. Updates of the object from 'sun is shining' to 'sun is shining' do not initiate a reference travel, if the output is still in the sun protection position at this time.

A reference travel by forced control will always be executed for synchronization purposes as described and also in such cases where the position data of the curtain or the slats are known. No reference travel by forced control will be executed at the end of shading.

For the sun protection parameters to be visible, the sun protection function must be enabled on parameter page "Ax – Enabled functions (x = number of output)".

The reaction at the beginning of sunshine/shading must be configured for fixed or variable position preset or for recalling an internal scene.

- Set the parameter "Reference travel before every sun protection positioning operation ?" on parameter page "Ax - Beginning of sun protection" (x = number of output) to "yes".

At the beginning of shading there is always a reference travel by forced control as described. The preset position will be approached after the end of the reference travel.

- Set the parameter "Reference travel before every sun protection positioning operation ?" on parameter page "Ax - Beginning of sun protection" (x = number of output) to "no".

A reference travel at the beginning of sun protection will only be executed, if the position data are unknown, for instance, after an ETS programming operation or after switch-on of the power supply. In all other cases, the preset shading position will be approached immediately.

- ❗ A reference travel is the time required for a travel movement into the upper end position increased by 20 % and additionally by the parameterized travel time extension. A reference travel is not retriggerable.
- ❗ Variable position preset: No reference travel will be executed, if new position values are preset via the bus while the sun protection is active.
- ❗ "Blind" mode of operation: A terminated reference travel of for the height of the blind synchronizes at the same time also the slat position.

Configuring the slat offset in the sun protection mode (only "Blind" mode of operation)

For the slat position at the beginning of shading, an offset can be specified separately for each output, if fixed or variable slat positions are to be approached.

If necessary, the slat offset can correct the fixed or variable nominal slat position and thus allow the creation of an individual shading situation, when the sun protection is active. The offset can be preset in two ways...

- The slat offset can be parameterized statically in the ETS. The parameterization of a static offset value allows to vary the degree of shading in those parts of the building that are not exposed to full sunshine due to objects in front of the building. The variable slat angle adjusted by the sun protection control or the fixed angle specified in a parameter can thus be overridden so that the slats are always opened a bit wider than originally preset. Alternatively, the slats can also be closed completely by means of the static offset if too much sunlight is reflected into the room.
- The slat offset can additionally be adapted by the bus via the separate communication object "Sunshine slat position offset". In this way, the desired slat offset can also be adjusted during an active shading cycle and independent of a direct operation as, for instance, the short-time mode. Thus, it is possible, for instance, that persons in a room can correct the slat angle at any time 'manually' and individually by selecting another preset value at a touch sensor or a visualization. An offset preset via the object overwrites the value parameterized in the ETS.

The preset offset is taken into account in the sun protection mode for each positioning move during an active shading cycle and added to the predefined nominal slat position. The offset value can be varied within a range from -100 % ... 0 ... 100 % so that the slats can be moved in both directions into the respective end positions (cf. Fig. 34). At an offset of "0 %", the actual slat position is always identical with the predefined nominal slat position for sun protection purposes.

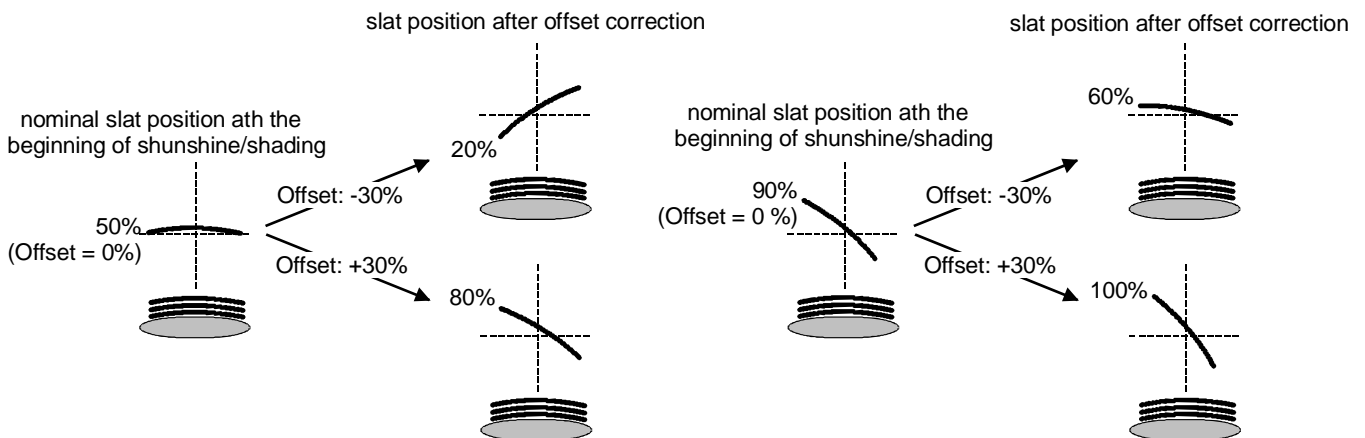

Fig. 34: Functional principle of slat offset
(example showing slat type 1 / slat type 2 identical)

The position value actually adjusted with the offset after adding the slat position value is always between 0 and 100 %. Minimum and maximum position are thus determined by the slat end positions. These limits cannot be exceeded by specifying an greater offset. Example (cf. Fig. 34)...

Slat position at the beginning of sunshine/shading = 90 %

Slat position offset at the beginning of sunshine/shading = +30 %

→ The resulting slat position is 100% as the end position is reached.

In acc. with the KNX datapoint type 6.001 (DPT_Percent_V8), the data format of the communication object "Sunshine slat position offset" permits presetting positive and negative values in a range of -128 ... 0 ... +127. The actuator interprets the value received directly as an offset in %. Values below -100 or above +100 are limited to the minimum (-100 %) and maximum offset (+100 %) and evaluated accordingly.

An offset preset via the object overwrites the value parameterized in the ETS. In the event of a bus voltage failure or a mains voltage failure of the actuator, an offset value received via the communication object can be stored internally in a non-volatile memory so that the offset value last received is not lost even in case the complete power supply fails (bus voltage and mains voltage failure). As an alternative, the offset preset via the bus can be reset (0 %) in the event of a power supply failure with the result that the value parameterized in the ETS is again used in operation. The offset reaction preset in the event of bus or mains voltage failure can be parameterized in the ETS.

For the sun protection parameters to be visible, the sun protection function must be enabled on parameter page "Ax – Enabled functions (x = number of output).

The function must be configured for the "Blind" mode of operation.

The reaction at the beginning of sunshine/shading must be configured for fixed or variable position preset.

- Set the parameter "Offset with fixed and variable slat position" on parameter page "Ax - Beginning of sun protection" (x = number of output) to "no offset".
The offset correction is deactivated. During shading (beginning of sunshine/shading), the fixed or variable slat position will be approached without offset correction. The other parameter relating to the offset are blanked out.
- Set the parameter "Offset with fixed and variable slat position" to "offset as parameterized"
The statical offset correction based on the parameter preset in the ETS is activated. During every shading operation (beginning of sunshine/shading), the nominal slat position is always corrected by the parameterized offset value.
- Set the parameter "Offset with fixed and variable slat position" to "offset as parameterized and via object"
The offset correction based on the parameter preset in the ETS and via the object is activated. The slat offset is preset by a fixed value parameterized in the ETS and can be adapted dynamically with a separate communication object. During every shading operation (beginning of sunshine/shading), the nominal slat position is always corrected by the preset offset value.

- Set the parameter "Slat offset position (-100 ... 100 %)" on parameter page "Ax - Beginning of sun protection" to the desired offset value.
The parameterized value defines the statical offset correction of the slat position. The parameterized value can be re-adjusted via the "Sunshine slat position offset" object, if the communication object has been enabled.
 - Set the parameter "Store slat position offset adjusted via object in case of bus / mains voltage failure ?" to "no".
The value received via the object will only be stored temporarily in volatile memory. Thus, the value received via the object only replaces the parameterized value only until the actuator is re-initialized (return of bus or mains voltage, if both voltages were off beforehand). After the initialization, the offset value parameterized in the ETS will be used again.
 - Set the parameter "Store slat position offset adjusted via object in case of bus / mains voltage failure ?" to "yes".
The value received via the object will be stored in case of bus or mains voltage failure in a non-volatile memory of the actuator. The originally parameterized offset value is definitely overwritten in the process. Only a new ETS programming operation sets the offset back to the parameterized value.
- ⓘ An offset value received via the bus is stored temporarily or permanently in the actuator and taken into account during the next shading operation. The reception of an offset value during an active shading phase (beginning of sunshine/shading active) results in an immediate and 'visible' correction of the offset angle by the output.
- ⓘ After an ETS programming operation, the offset is always set to the value parameterized in the ETS.
- ⓘ Storage of the slat offset position in case of bus/mains voltage failure: The offset value preset via the object is stored only if one part of the supply voltage (mains or bus) is still present or if the supply fails completely after the mains voltage has been available before without interruption for at least 20 seconds after the last reset (storage capacitors sufficiently charged for storage purposes). In all other cases nothing is stored.
- ⓘ The slat offset has no influence on the behaviour of an output at the end of a shading phase (end of sunshine/shading).

Presetting the reaction at the end of sunshine / shading

At the end of the shading phase – if applicable, after the end of the delay time – the output concerned will show the preset reaction, if no function with a higher priority is active at the time of deactivation. The preset reaction will not be executed either at the end of a shading phase, if the sunshine signal is overridden on account of priority settings by a direct operation.

The reaction at the end of shading is preset on parameter page "Ax - End of sun protection" (x = number of output). Depending on the selected mode of operation, the ETS adapts the designations of the parameter settings ("raising" ↔ "opening the louver" / "lowering" ↔ "closing the louver").

For the sun protection parameters to be visible, the sun protection function must be enabled on parameter page "Ax – Enabled functions (x = number of output).

- Set the parameter "Reaction at the end of sunshine / shading" to "no reaction".
At the end of shading, the relay of the output shows no reaction. Any travel movements still in progress at this instant will still be finished.
 - Set the parameter "Reaction at the end of sunshine / shading" to "raising" or "opening the louver".
At the end of shading, the actuator raises the curtain or opens the venting louver.
 - Set the parameter "Reaction at the end of sunshine / shading" to "lowering" or "closing the louver".
At the end of shading, the actuator lowers the curtain or closes the venting louver.
 - Set the parameter "Reaction at the end of sunshine / shading" to "stop".
At the end of shading, the actuator switches the relays of the output to the "stop" position. A travel movement in progress, if any, will be interrupted.
 - Set the parameter "Reaction at the end of sunshine / shading" to "position tracking".
At the end of shading, the output will be set to the state last adjusted statically before sun protection or to the state tracked and internally stored during sun protection. The position objects, the long-time object and the scene function are tracked.
- ❗ The behaviour preset in this parameter will only be executed, if no function with a higher priority (e.g. safety) is activated when the sun protection is enabled or when a direct operation has not overridden the sunshine signal on account of priority settings.
- ❗ Parameter setting "Position tracking": The switching/shutter actuator can track absolute positions (position telegram, scene value) at the end of sun protection only if the position data are known and if the positions have been predefined. There is otherwise no reaction at the end of shading. Position data can be tracked, if the output was in a defined position before the sun protection function or if a new position telegram was received via the positioning objects during the sun protection. In the latter case, a reference travel will be executed at the end of sun protection, if the position before or during the sun protection was unknown. Known slat positions will also be tracked as described. This is also the case, when the height of the blind is unknown. Long-time travel movements (travels without position preset) will, however, always be tracked.

Sun protection application examples

The present chapter describes different applications of the sun protection function of the switching/shutter actuator in combination with the Berker KNX / EIB Weather Station (order no. 7541 40 03) and the combination sensor (order no. 7590 00 57).

For each application, the examples describe which of the communication objects of the weather station must be linked with the shutter actuator.

Instructions concerning the required configuration of the KNX / EIB weather station can be found in the corresponding product documentation.

– I. Sun protection with brightness limit value monitoring and fixed sun protection positions:

The limit value monitoring function of the weather station is used. The weather station transmits a "1" telegram via the "Limit value 1 [Sun...]" to the bus, when a preset brightness limit value is exceeded. The switching/shutter actuator activates the shading function and adjusts the curtain to the corresponding fixed sun protection position. In the operating mode "Blind" of the shutter actuator, the fixed slat position specified in the parameter is recalled in addition.

When the brightness drops below the limit value for the measured brightness (with hysteresis, if programmed), the weather station transmits a "0" telegram to the bus. This deactivates the shading function in the switching/shutter actuator and the corresponding reaction at the end of sunshine /shading will be executed. The communication objects must be linked as shown in Fig. 35.

Required parameterization of the switching/shutter actuator (parameters not listed are optional):

- polarity of the "Sunshine / shading facade" object = "1" sunshine,
- reaction at the beginning of sunshine / shading = fixed position,
- fixed positions setting.

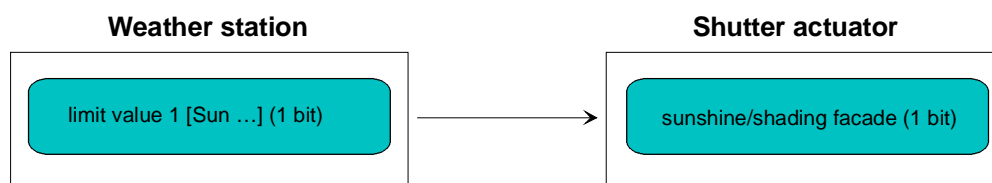

Fig. 35: Programming of the communication objects for application example I

- II. Sun protection with shading control and fixed sun protection positions:

The shading control of the weather station is used. When the preset basic brightness for shading operations is exceeded, the weather station transmits a 1-bit telegram of value "1" via the "Shading facade [shading control facades 1-4]" to the bus. The switching/shutter actuator activates the shading function and adjusts the curtain to the corresponding fixed sun protection position. In the operating mode "Blind" of the switching/shutter actuator, the fixed slat position specified in the parameter is recalled in addition.

When the brightness drops below the basic brightness for shading operations (with hysteresis, if programmed), the weather station transmits a "0" telegram to the bus. This deactivates the shading function in the switching/shutter actuator and the corresponding reaction at the end of sunshine /shading will be executed. The communication objects must be linked as shown in Fig. 36.

Required parameterization of the switching/shutter actuator (parameters not listed are optional):

- polarity of the "Sunshine / shading facade" object = "1" sunshine,
- reaction at the beginning of sunshine / shading = fixed position,
- fixed positions setting.

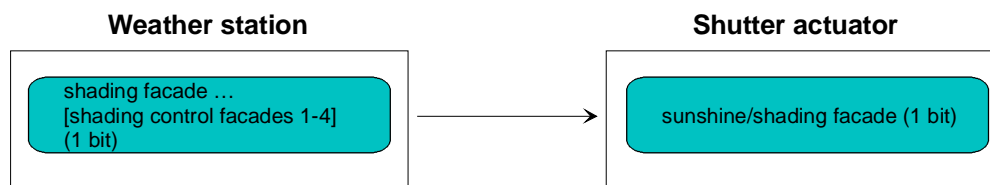

Fig. 36: Programming of the communication objects for application example II

- III. Sun protection with shading control and fixed curtain height and variable slat position tracking:

The shading control of the weather station is used. The blinds connected to the switching/shutter actuator are slatted blinds. When the basic brightness for shading operations is exceeded, the weather station transmits a 1-bit telegram of value "1" via the "Shading facade [shading control facades 1-4]" to the bus. The switching/shutter actuator activates the shading function and adjusts the fixed sun protection position corresponding to the height of the blind.

The individual facade control of the weather station transmits additionally the slat position to be preset for sun-dependent slat tracking via the 1-byte object "Slat position (%) facade [individual control facade ...]" to the bus. The slat position required for shading will thus be adjusted in the switching/shutter actuator.

When the brightness drops below the basic brightness for shading operations (with hysteresis, if programmed), the weather station transmits a "0" telegram via the "Shading facade [shading control facade 1-4]" to the bus. This deactivates the shading function in the switching/shutter actuator and the corresponding reaction at the end of sunshine /shading will be executed.

Ideally, the telegram "Slat position (%) facade [individual facade control ...]" = "0 %" is suppressed in the weather station by means of a parameter. The extra slat positioning movement might otherwise adversely affect the behaviour of the output at the end of shading (possibly brief bucking).

The communication objects must be linked as shown in Fig. 37.

Required parameterization of the switching/shutter actuator (parameters not listed are optional):

- polarity object "Sunshine / shading facade" = "1" sunshine,
- reaction at the beginning of sunshine/shading = fixed blind position, variable slat position,
- fixed blind position setting.

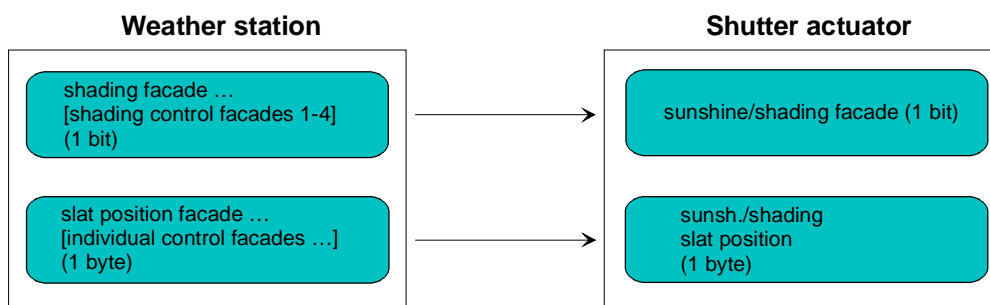

Fig. 37: Programming of the communication objects for application example III

– IV. Sun protection with shading control and variable curtain height and variable slat position tracking:

The shading control of the weather station is used. The blinds connected to the switching/shutter actuator are slatted blinds. When the basic brightness for shading operations is exceeded, the weather station transmits a 1-bit telegram of value "1" via the "Shading facade [shading control facades 1-4]" to the bus. The switching/shutter actuator activates the shading function. The individual facade control of the weather station transmits additionally the slat position to be preset for sun-dependent slat tracking via the 1-byte object "Slat position (%) facade [individual control facade ...]" and the blind height to be adjusted via the 1-byte object "Shading facade curtain height threshold/position [individual control facade ...]" to the bus. The slat position and the blind height required for shading will thus be adjusted in the switching/shutter actuator. When the brightness drops below the basic brightness for shading operations (with hysteresis, if programmed), the weather station transmits a "0" telegram via the "Shading facade [shading control facade 1-4]" to the bus. This deactivates the shading function in the switching/shutter actuator and the corresponding reaction at the end of sunshine /shading will be executed.

Ideally, the telegrams "Slat position (%) facade [individual facade control ...]" = "0 %" and "Shading facade curtain height threshold/position [individual control facade ...]" = 0 % are suppressed in the weather station by means of a parameter. The extra slat and blind positioning movement might otherwise adversely affect the behaviour of the output at the end of shading (possibly brief bucking).

The communication objects must be linked as shown in Fig. 38.

Required parameterization of the switching/shutter actuator (parameters not listed are optional):

- polarity object "Sunshine / shading facade" = "1" sunshine,
- reaction at the beginning of sunshine / shading = variable blind position, variable slat position.

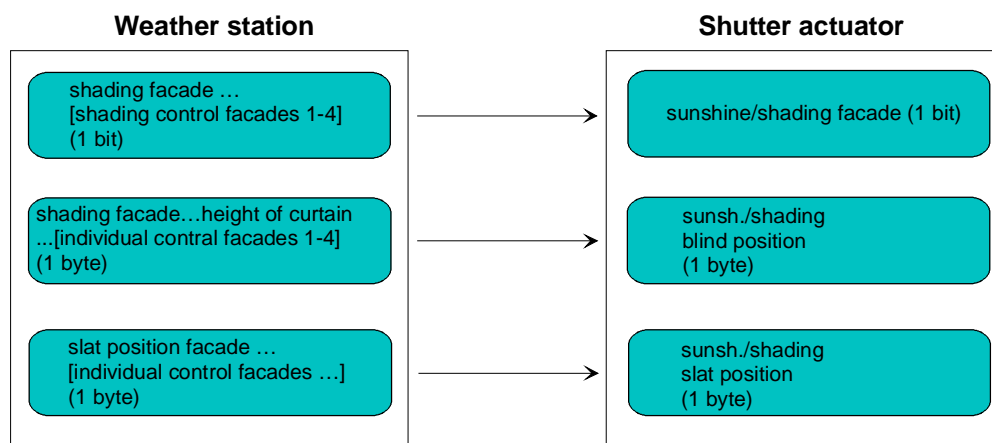

Fig. 38: Programming of the communication objects for application example IV

- V. Sun protection with shading control and variable curtain height and fixed slat position:

The shading control of the weather station is used. The blinds connected to the switching/shutter actuator are slatted blinds. When the basic brightness for shading operations is exceeded, the weather station transmits a 1-bit telegram of value "1" via the "Shading facade [shading control facades 1-4]" to the bus. The switching/shutter actuator activates the shading function and adjusts the corresponding fixed sun protection position for the slat angle.

The individual facade control of the weather station transmits additionally the blind height to be adjusted via the 1-byte object "Shading facade curtain height threshold/position [individual control facade ...]" to the bus. The blind height required for shading will thus be adjusted in the switching/shutter actuator.

When the brightness drops below the basic brightness for shading operations (with hysteresis, if programmed), the weather station transmits a "0" telegram via the "Shading facade [shading control facade 1-4]" to the bus. This deactivates the shading function in the switching/shutter actuator and the corresponding reaction at the end of sunshine /shading will be executed.

Ideally, the telegram "Shading facade curtain height threshold/position [individual control facade ...]" = 0 % is suppressed in the weather station by means of a parameter. The extra blind positioning movement might otherwise adversely affect the behaviour of the output at the end of shading (possibly brief bucking).

The communication objects must be linked as shown in Fig. 39.

Required parameterization of the switching/shutter actuator (parameters not listed are optional):

- polarity object "Sunshine / shading facade" = "1" sunshine,
- reaction at the beginning of sunshine / shading = variable blind position, fixed slat position,
- fixed blind position setting.

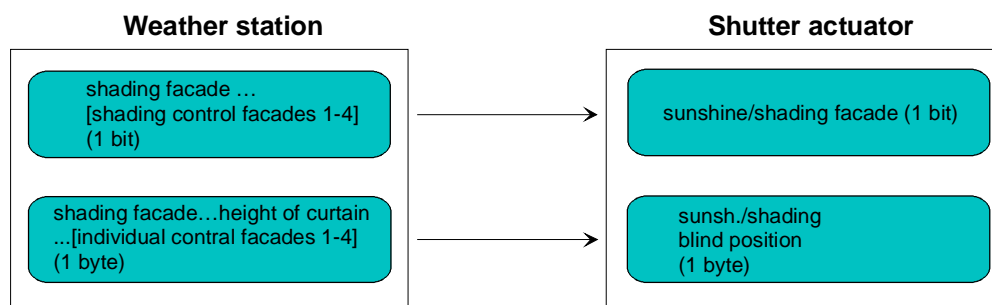

Fig. 39: Programming of the communication objects for application example V

Scene function (only in ETS 3.0d and onwards)

An actuator can hold up to 8 scenes for each output and store scene position values for the height of a blind, shutter or awning or the position of a venting louver. In the 'Blinds' mode, the user can also preset slat positions. The scene values are recalled or stored via a separate scene extension object by means of extension telegrams. A scene recall can optionally also be delayed.

The datapoint type of the extension object permits addressing of up to 64 scenes max. For this reason, the scene number (1...64) with which the internal scene (1...8) is addressed can be determined in the parameterization of a scene.

The scene function must have been enabled on parameter page "Ax – Enabled functions" separately for each output before the required communication objects and parameters (on parameter page "Ax – Scenes") become visible.

Like the control of an output via short-time, long-time, central or position telegrams, the scene function belongs to the direct operation mode. For this reason, a recalled scene position can at any time be overridden by a manual control, a forced position (only in ETS3.0d and onwards) or a safety function. The scene position last recalled can also be readjusted by other telegrams of the direct operation mode. The priority of direct operation and also of the scene function can be parameterized with respect to the sun protection function (cf. "Sun protection function").

Presetting a scene recall delay for the scene function

Each scene recall of an output can optionally also be delayed. With this feature, dynamical scene sequences can be configured if several outputs are combined with cyclical scene telegrams.

The scene function must be enabled on parameter page "Ax – Enabled functions (x = number of output).

- Set the parameter "Delay scene recall?" on parameter page "Ax – Scenes" to "yes"
 - The delay time is now activated and can be parameterized separately. The delay only influences the scene recall of the output. The delay time is started on arrival of a recall telegram. The corresponding scene will be recalled and the output set to the respective scene position value only after this time has elapsed.
- ❗ Each scene recall telegram restarts the delay time and retriggers it. If a new scene recall telegram is received while a delay is active (scene recall not yet executed), the old (and not yet recalled scene) will be rejected and only the scene last received executed.
- ❗ The scene recall delay has no influence on the storage of scene values. A scene storage telegram within a scene recall delay terminates the delay and thus the scene recall.
- ❗ In case of bus voltage failure, all time functions will be stopped. Therefore, all scene recalls that are still in the delay stage will be aborted. A scene recall received shortly before bus voltage failure is then lost, if the corresponding delay has not yet elapsed. A delayed scene recall will also be aborted, if a function with a higher priority (manual control, forced position, safety, sun protection, if the priority is the same as or higher than that of direct operation) is activated. The scene recall is nevertheless stored internally so that the scene positions last recalled can be tracked at the end of a higher-ranking function.

Presetting the ETS download behaviour for the scene function

During storage of a scene, the scene values are stored permanently in the device (cf. "Presetting the storage behaviour for scene functions"). To prevent the stored values from being replaced during ETS programming of the application or of the parameters by the originally programmed scene position values, the actuator can inhibit overwriting of the scene values. As an alternative, the original values can be reloaded into the device during each programming run of the ETS.

The scene function must be enabled on parameter page "Ax – Enabled functions (x = number of output).

- Set the parameter "Overwrite the values stored in the device during an ETS download ?" on parameter page "Ax – Scenes" to "Yes".
During each ETS programming of the application or of the parameters, the scene values parameterized in the ETS for the output concerned will be programmed into the actuator. Scene values stored in the device by means of a storage function will be overwritten, if any.
 - Set the parameter "Overwrite the stored values in the device during an ETS download ?" on parameter page "Ax – Scenes" to "Yes".
Scene values stored in the device with a storage function will be maintained. If no scene values have been stored, the position values last programmed in the ETS remain valid.
- i** When the actuator is put into operation for the first time, this parameter should be set to "yes" so that the output is initialized with valid scene values. In the shutter actuator as delivered, the scene positions are internally set to default values as in the ETS product database.

Presetting scene numbers

The datapoint type of the scene extension object permits addressing of up to 64 scenes max. For this reason, the scene number (1...64) with which the scene is addressed, i.e. recalled or stored, must be determined for each internal scene (1...8) of the output.

The scene function must be enabled on parameter page "Ax – Enabled functions (x = number of output).

- Set the parameter "Scene y activatable by scene number" (y = number of the scene (1...8)) on parameter page "Ax – Scenes" for each scene to the numbers with which the scenes are to be addressed.
A scene can be addressed with the parameterized scene number. A setting of "0" deactivates the corresponding scene so that neither recalling nor storage is possible.
- i** If the same scene number is parameterized for several scenes, only the scene with the lowest internal scene number (1...8) will be addressed. The other internal scenes will be ignored in this case.

Presetting scene positions

Moreover, the position value (blind, shutter, awning, venting louver position) to be set for the output in case of a scene recall must be specified as well. In the "Blind" mode, the height of the blind and the slat position can be preset.

The scene function must be enabled on parameter page "Ax – Enabled functions (x = number of output).

- Set the parameter "Position ... for scene y" (y = number of the scene (1...8)) on parameter page "Ax – Scenes" for each scene to the desired position (0 %...100 %).

In case of a scene recall, the output is set to the parameterized position.

- ❗ The parameterized position values are adopted in the actuator during programming with the ETS only if the parameter "Overwrite values stored in the device during an ETS download ?" is set to "yes".
- ❗ Before approaching the required scene position, the switching/shutter actuator performs a reference travel, if the current position data are unknown (e.g. after an ETS programming operation or after switch-on of the supply voltage).

Presetting the storage behaviour for the scene function

The current position value of a blind, shutter, awning, venting louver and also of a slat can be stored internally via the extension object on reception of a scene storage telegram. The position value can be influenced before storage by all functions of the output (e.g. short-time and long-time operation, central or scene recall telegram, safety and sun protection function and manual control).

The scene function must be enabled on parameter page "Ax – Enabled functions (x = number of output).

- Set the parameter "Storage function for scene y" (y = number of the scene (1...8)) on parameter page "Ax – Scenes" for each scene to "yes".
The storage function is activated for the scene in question. On reception of a storage telegram via the "Scene extension" object, the current position value will be internally stored.
- Set the parameter "Storage function for scene y" (y = number of the scene (1...8)) on parameter page "Ax – Scenes" for each scene to "no".
The storage function is deactivated for the scene in question. A storage telegram received via the "scene extension" object will be rejected.

- ❗ The following rules apply for the position data to be stored:
The current curtain, slat and louver positions are stored. With blinds, the height to be stored is always referred to a slat position of 100 %. Positions temporarily approached will be stored also for those outputs that are involved in a travel movement at the time of data storage.
On account of the fact that position data are stored as integer percentage values (0...100), a minor deviation from the positions adjusted later during a scene recall cannot be avoided.
The data are stored only if the mains voltage was available beforehand during at least 20 seconds after the last reset (storage capacitors sufficiently charged for storage purposes). The data will not be stored, if the position data are unknown.

Forced position (only in ETS 3.0d and onwards)

The forced position function can be enabled for blind output. The forced position has the second highest priority after manual control. It therefore overrides the safety function, the sun protection function and the direct operation (short-time, long-time telegram, scenes, positioning , central). During a forced-position state, the output concerned is locked so that it can no longer be controlled with functions of a lower priority, but only with a manual control. At the end of a manual control, the forced-position action is re-executed if the forced position is still active.

The forced position function has a separate 2-bit communication object for each output. The state of the output in case of a forced position function is directly determined by the forced-position telegram. The first bit (bit 0) of the "Forced position" object specifies the travel direction to be forced onto the output as in long-time operation. The second bit (bit 1) activates or deactivates the forced-position state(cf. table 3).

Bit 1	Bit 0	Function
0	x	Forced position not active ⇒ normal control
0	x	Forced position not active ⇒ normal control
1	0	Forced position active: raising / opening the louver
1	1	Forced position active: lowering / closing the louver

Table 3: Bit coding of forced position

The behaviour of an output at the end of the forced-position function can be parameterized. The forced-position object can moreover be initialized on return of bus voltage. A mains failure alone (bus voltage present) has no effect on the state of the forced-position object. In case of a return of only the mains voltage, a previously activated forced position remains active.

- ❗ The forced-position travel time required by an output to move the drive into the end positions is determined by the "Travel time" parameter on parameter page "Ax - Time settings". Like the long-time operation, a forced-position travel is derived from the travel time. Downward travel: travel time + 20 %; Upward travel: travel time + 20 % + parameterized or taught-in travel time extension. Forced-position travels are not retriggerable.
- ❗ The slats of blinds are not repositioned at the end of forced-position travels into the end positions.
- ❗ Updates of the forced position object from "forced position active" to "forced position active" while maintaining the forced travel direction or from "forced position inactive" to "forced position inactive" show no reaction.
- ❗ After programming of the application or of the parameters with the ETS, the forced position is always cancelled.
- ❗ The forced position function remains active even after a bus voltage failure as long as the mains voltage supply is still on. The forced position function will therefore be executed again at the end of a temporary or permanent manual control – if enabled in case of bus failure – even if there is no bus voltage.
- ❗ The current state of the forced position function will be stored in case of bus or mains voltage failure.

Enabling the forced position function

The forced position function can be enabled separately for each output.

- Set the parameter "Forced position function" on parameter page "Ax - Enabled functions" (x = number of output) to "enabled".

The forced position function is enabled. The corresponding communication object is created and the respective parameters on parameter page "Ax – Forced position" become visible.

Presetting the behaviour at the end of the forced position function

The behaviour of an output at the end of the forced-position function can be parameterized depending on the channel. The behaviour is parameterized on parameter page "Ax – Forced position" (x = number of output).

The forced position function of an output must be enabled on parameter page "Ax – Enabled functions" (x = number of output). Only then are the channel-related parameters for the forced position function visible.

- Set the parameter "Behaviour at the end of the forced position function" to "position tracking".
At the end of a forced position function, the output will be set to the state adjusted statically before the forced position function or to the state tracked and internally stored during the forced position function. The position objects, the long-time object and the scene function are tracked.
- Set the parameter "Behaviour at the end of the forced position function" to "no change".
At the end of forced position function, the state last adjusted will not be changed. Thereafter, the output is again enabled. Any travel movements still in progress at this instant will still be finished.

- i** Parameter setting "Position tracking": The switching/shutter actuator can track absolute positions (position telegram, scene value) during activated forced control only if the position data are known and if positions have been predefined. If this is not the case, no reaction takes place at the time forced control is enabled.
Position data can be tracked, if the output has been in a defined position before the forced position function or if a new position telegram has been received via the position objects while the forced position function was interlocked. In the latter case, a reference travel will be executed when the forced position function is enabled, if the position was unknown before or during the safety interlock. Known slat positions will also be tracked as described. This is also the case, when the height of the blind is unknown.
Long-time travel movements (travels without position preset) will, however, always be tracked.
- i** The preset "Behaviour at the end of the forced position function" will only be executed, if the output passes over to direct operation at the end of the forced position function. If a safety function or a sun protection function is activated (independent of the preset priority with respect to direct operation), the function with the next lower priority will be executed.
The parameterized behaviour will not be executed either if the forced position function is terminated by a preset on return of bus voltage. In this case, the preset "Behaviour after bus/mains voltage return" will be executed.

Presetting the behaviour of the forced position function after bus voltage return

The communication object of the forced position function can be initialized after bus voltage return. In this way, an output can be influenced and interlocked on bus initialization when the forced position function is being activated.

A mains failure alone has no effect on the forced position function. In case of a return of only the mains voltage, a previously activated forced position remains active.

The behaviour after bus voltage return with regard to the forced position function is parameterized separately for each output on the parameter pages "Ax – Forced position" (x = number of output). Depending on the selected mode of operation, the ETS adapts the designations of the parameter settings ("raising" ↔ "opening the louver" / "lowering" ↔ "closing the louver").

After bus return, the parameterized state is taken over into the "Forced position" communication object.

The forced position function of an output must be enabled on parameter page "Ax – Enabled functions" (x = number of output). Only then are the channel-related parameters for the forced position function visible.

- Set the parameter "Behaviour after bus voltage return" to "no forced position active".
After bus voltage return, the forced position function is deactivated. In this case, the preset "Behaviour after bus/mains voltage return" will be executed on return of bus voltage.
- Set the parameter "Behaviour after bus voltage return" to "forced position function ON, raising" or "forced position function ON, opening the louver".
The forced position function is activated after bus voltage return and the curtain raised or the venting louver opened by forced control. The output concerned is interlocked by forced control until an enable signal is received via the bus. The parameter "Behaviour after bus voltage return" will in this case not be evaluated for the output concerned.
- Set the parameter "Behaviour after bus voltage return" to "forced position function ON, lowering" or "forced position function ON, closing the louver".
The forced position function is activated after bus voltage return and the curtain raised or the venting louver opened by forcing. The output concerned is interlocked by forced control until an enable signal is received via the bus. The parameter "Behaviour after bus voltage return" will in this case not be evaluated for the output concerned.
- Set the parameter "Behaviour after bus voltage return" to "state of forced position before bus/mains failure".
After bus voltage return, the forced-position state last selected and internally stored before bus or mains voltage failure will be tracked. An ETS programming operation deletes the stored state (reaction in that case same as with "no forced position active").
If the tracked state corresponds to "no forced position active", the parameter "Behaviour after bus/mains voltage return" will be executed on return of bus voltage.

- ❗ Setting or tracked state "no forced position active": The reaction of the output concerned after return of bus voltage is defined by the parameter "Behaviour after bus/mains voltage return".
- ❗ After programming of the application or of the parameters with the ETS, the forced position is always cancelled.

'Fabric-stretching' function

In the shutter/awning mode of operation, the Fabric-stretching function can be activated. The Fabric-stretching function permits stretching the fabric of an awning tight after lowering. The fabric-stretching function can also be used with shutters to re-open the slits of the shutter curtain after a downward movement into the lower end position.

If activated in the ETS parameters, fabric stretching is executed during each downward travel after stopping and after the parameterized changeover delay has elapsed. The curtain is then 'stretched' by moving briefly into the opposite travel direction (cf. Fig. 40).

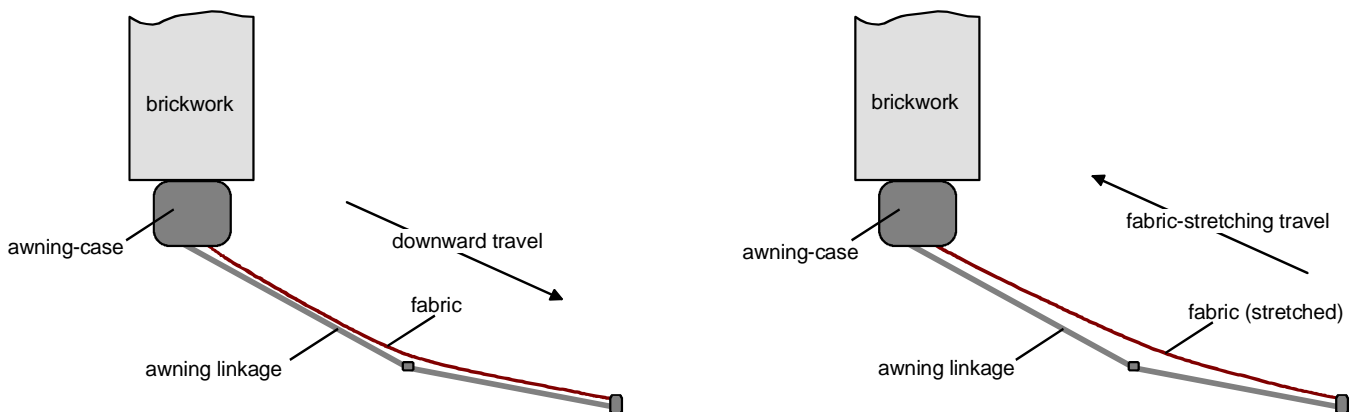

Fig. 40: Fabric-stretching in an awning

The downward travel can be triggered by any of the following events: Long-time, short-time or position telegram, forced position, safety or sun protection function, central telegram or scene recall and also the manual control.

Sheet- stretching is never effected in upward travel movements.

- ❗ Fabric stretching affects the determination of positions and the position feedback since a fabric-stretching movement changes the position of a shutter or an awning. In a positioning move into the lower end position (100 %), the position value reported back after the fabric-stretching operation will always be a smaller one.
- ❗ Fabric-stretching cannot be parameterized in the blind or louver modes of operation.

Activating the fabric-stretching function

The fabric-stretching function can be activated independently for each shutter or awning output on parameter page "Ax – Enabled functions" (x = number of output).

The mode of operation selected must be the "Shutter/awning" mode.

- Set the parameter "Fabric-stretching function" to "enabled".
Parameter page "Ax – Fabric-stretching" is enabled and the fabric-stretching function is activated.

i Fabric-stretching cannot be parameterized in the blind or louver modes of operation.

Presetting the fabric-stretching function

The fabric-stretching function can be parameterized independently for each shutter or awning output on parameter page "Ax – Fabric-stretching" (x = number of output). The travel time required for fabric stretching by means of a movement in opposite direction can be parameterized.

The fabric-stretching function must be activated.

- Select the desired value for the "Time for fabric-stretching" parameter.
After the end of a downward travel the curtain stops and – after elapsing of the changeover delay – moves backwards in opposite direction for a period corresponding to the parameterized fabric-stretching time.

i The time for fabric stretching must be selected shorter than the parameterized or measured travel time of the shutter or awning. Otherwise, risk of malfunction.

i Fabric stretching will only be effected if the downward movement lasts longer than the parameterized fabric-stretching time.

4.2.4.3 Delivery state

In the state as delivered, the actuator is passive, i.e. no telegrams are transmitted to the bus. The outputs can, however, be operated by manual control on the device, if the mains voltage is on. In the manual control mode, no feedback telegrams are sent to the bus. All other functions of the actuator are deactivated.

The device can be programmed and put into operation with the ETS. The physical address is preset to 15.15.255.

Moreover the device has been configured at the factory with the following characteristics...

- Channel definition: all outputs configured for shutter operation
- Travel time (continuous run): 1 minute
- Travel time extension 2 %
- Break during travel direction changeover 1 s
- Response to bus voltage failure: no reaction
- Behaviour on return of bus or mains voltage: stop

4.2.5 Parameters

Description:	Values:	Remarks:
 General		
Delay after bus voltage return Minutes (0...59)	0...59	<p>To reduce telegram traffic on the bus line after bus voltage activation (bus reset), after connection of the device to the bus line or after programming with the ETS, it is possible to delay all active feedbacks of the actuator. The parameter specifies in this case a delay valid for all devices. Feedback telegrams for initialization will therefore be transmitted to the bus only after the parametrized time has elapsed.</p> <p>Setting the minutes of the delay time.</p>
Seconds (0...59)	0...17...59	<p>Setting the delay time seconds.</p>
Central function for outputs in switching mode ?	yes no	<p>Setting "yes" enables the central function and thus the "Central switching" object. Individual switching outputs can be assigned to the central function only if the function is enabled</p>
Central object polarity	0 = switching off; 1 = switching on 0 = switching on; 1 = switching off	<p>The parameter sets the polarity of the central object.</p>
Central function for outputs in shutter mode ?	yes no	<p>Setting "yes" enables the central function and thus the "Central travel control" object. Individual shutter outputs can be assigned to the central function only if the function is enabled.</p>
Central object polarity	0 = UP; 1 = DOWN 0 = DOWN; 1 = UP	<p>This parameter defines the polarity of the central object.</p>

<p>Make use of centralized feedback ?</p>	<p>no yes, active message object yes, passive status object</p>	<p>To keep the telegram load low during a 'bus initialization', the centralized feedback function of the actuator can be employed. Setting "yes" activates the centralized feedback and enables the corresponding object. The parameter moreover defines whether the feedback telegrams are transmitted actively (telegram transmission in case of changes) or passively (telegram transmission only as a response to a 'Read' request). The communication flags of the object are automatically set by the ETS according to the setting.</p>
<p>Time delay for feedback telegram after bus voltage return ?</p>	<p>yes no</p>	<p>The centralized feedback telegram can be transmitted to the bus with a delay after bus voltage return or after programming with the ETS. Setting "Yes" activates the delay time of the centralized feedback in case of bus voltage return. The delay time is parameterized under "General" (see above). i This parameter is visible as an active message object only if centralized feedback is enabled.</p>
<p>Cyclical transmission of centralized feedback telegram ?</p>	<p>Yes (transm. cyclic and in case of changes) No (transmission only in case of changes)</p>	<p>The object value of the centralized feedback can be transmitted cyclically. The feedback telegram is transmitted to the bus cyclically and after state changes. The cycle time is generally programmed under the "Time settings" entry for all feedback telegrams. The feedback telegram is transmitted to the bus only after state changes. i This parameter is visible as an active message object only if centralized feedback is enabled.</p>

Blinking rate **1 s**
(all assigned switching **2 s**
outputs) **5 s**
 10 s

At the beginning and at the end of a disabling function (if used), switching outputs can also be parameterized as "blinking". In this case, the outputs change the switching state cyclically. The "Blinking rate" parameter generally defines the ON-time and the OFF-time of a "blinking" output signal for all outputs.

Example:

Blinking rate = 1 s

→ 1 s off → 1 s on → 1 s off ...

 Switching outputs time settings

Time for cyclical transmission of feedback tel.
Hours (0...23) **0...23**

Depending on parameterization, the different active feedback telegrams of the actuator can transmit their state also cyclically to the bus.
The parameter "Time for cyclical transmission of feedback tel." generally defines the cycle time for all outputs.

Setting the cycle time hours.

Minutes (0...59) **0...2...59**

Setting the cycle time minutes.

Seconds (10...59) **10...59**

Setting the cycle time seconds.

Default setting: 2 minutes 10 seconds

 Shutter outputs safety

Safety functions:	disabled enabled	If it is intended to make use of the 5 safety functions of the actuator and to parameterize them, the function must be enabled for all channels (setting: "enabled"). If the safety functions are deactivated (setting: "disabled"), any programmed assignment of individual shutter outputs to safety monitoring functions is not operational.
Wind alarm 1	disabled enabled	This parameter can be used to enable the first wind alarm and thus to enable the communication object (setting: "enabled"). If the first wind alarm is deactivated (setting: "disabled"), any programmed assignment of individual shutter outputs to wind alarm 1 is not operational.
Wind alarm 2	disabled Enabled	This parameter can be used to enable the second wind alarm and thus to enable the communication object (setting: "enabled"). If the second wind alarm is deactivated (setting: "disabled"), any programmed assignment of individual shutter outputs to wind alarm 2 is not operational.
Wind alarm 3	disabled enabled	This parameter can be used to enable the first wind alarm and thus to enable the communication object (setting: "enabled"). If the third wind alarm is deactivated (setting: "disabled"), any programmed assignment of individual shutter outputs to wind alarm 3 is not operational.
Rain alarm	disabled enabled	This parameter can be used to enable the rain alarm and thus to enable the communication object (setting: "enabled"). If the rain alarm is deactivated (setting: "disabled"), any programmed assignment of individual shutter outputs to the rain alarm is not operational.

Frost alarm	disabled enabled	This parameter can be used to enable the frost alarm and thus to enable the communication object (setting: "enabled"). if the frost alarm is deactivated (setting: "disabled"), any programmed assignment of individual shutter outputs to the frost alarm is not operational.
Priority of safety alarms	wind → rain → frost wind → frost → rain rain → wind → frost rain → frost → wind frost → rain → wind frost → wind → rain	This parameter defines the priority ranking of the individual safety alarms. Interpretation: high → medium → low. <input type="checkbox"/> The three wind alarms have the same priority with respect to one another. <input type="checkbox"/> The safety alarm enabling parameters and the priority parameter is only visible when the safety functions are enabled.

 Shutter outputs safety times

<p>Use wind alarm monitoring function ? (only if wind alarms are enabled!)</p>	<p>yes no</p>	<p>If the wind alarms enabled under "Shutter outputs safety" are to be monitored cyclically for incoming telegrams to the safety objects, the monitoring function must be enabled here (setting: "yes"). In the opposite case (setting: "no"), the objects are not monitored cyclically .</p> <p>i As soon as the monitoring function is activated, telegrams must be transmitted cyclically to all enabled wind alarm objects.</p> <p>i The monitoring function may only be activated, if at least one wind alarm has been activated under "Shutter outputs safety".</p>
<p>Wind alarm monitoring time Hours (0...23)</p>	<p>0...23</p>	<p>This parameter is used for programming the wind alarm monitoring time.</p> <p>Sets the monitoring time hours.</p>
<p>Minutes (1...59)</p>	<p>1...25 59</p>	<p>Sets the monitoring time minutes.</p> <p><i>Presetting: 25 minutes</i></p> <p>i The cycle time of the transmitter should be less than half the parameterized monitoring time of the actuator.</p> <p>i The times can only be set, if wind alarm monitoring is activated.</p>
<p>Use rain alarm monitoring function ?</p>	<p>yes no</p>	<p>If the rain alarm enabled under "Shutter outputs safety" is to be monitored cyclically for incoming telegrams to the safety object, the monitoring function must be enabled here (setting: "yes"). In the opposite case (setting: "no"), the object is not monitored cyclically .</p> <p>i As soon as the monitoring function is activated, telegrams must be transmitted cyclically to the enabled rain alarm object.</p> <p>i The parameter is only visible, if the rain alarm has been enabled under "Shutter outputs safety".</p>

Rain alarm monitoring time Hours (0...23)	0...23	This parameter is used for programming the rain alarm monitoring time. Sets the monitoring time hours.
Minutes (1...59)	1...2...59	Sets the monitoring time minutes. <i>Presetting: 2 minutes</i> <input type="checkbox"/> The cycle time of the transmitter should be less than half the parameterized monitoring time of the actuator. <input type="checkbox"/> The times can only be set, if rain alarm monitoring is activated.
Use frost alarm monitoring function ?	yes no	If the rain alarm enabled under "Shutter outputs safety" is to be monitored cyclically for incoming telegrams to the safety object, the monitoring function must be enabled here (setting: "yes"). In the opposite case (setting: "no"), the object is not monitored cyclically. <input type="checkbox"/> As soon as the monitoring function is activated, telegrams must be transmitted cyclically to the enabled frost alarm object. <input type="checkbox"/> The parameter is only visible, if the frost alarm has been enabled under "Shutter outputs safety".
Frost alarm monitoring time Hours (0...23)	0...23	This parameter is used for programming the frost alarm monitoring time. Sets the monitoring time hours.
Minutes (1...59)	1...2...59	Sets the monitoring time minutes. <i>Presetting: 2 minutes</i> <input type="checkbox"/> The cycle time of the transmitter should be less than half the parameterized monitoring time of the actuator. <input type="checkbox"/> The times can only be set, if frost alarm monitoring is activated.

 Manual control

Manual control in case of bus voltage failure	<p>disabled</p> <p>enabled</p>	<p>This parameter can be used for programming whether manual control is to be possible (enabled) or deactivated in case of bus voltage failure.</p>
Manual control during bus operation	<p>disabled</p> <p>enabled</p>	<p>This parameter can be used for programming whether manual control is to be possible (enabled) or deactivated during bus operation (bus voltage on).</p>
Disabling function ?	<p>yes</p> <p>no</p>	<p>Manual control can be disabled via the bus, even if it is already active. For this purpose, the disabling object can be enabled here.</p>
Polarity of disabling object	<p>0 = enabled; 1 = disabled</p> <p>0 = disabled; 1 = enabled</p>	<p>This parameter defines the polarity of the disabling object.</p> <p><input type="checkbox"/> Only visible if the disabling function for manual control is enabled.</p>
Transmit status ?	<p>yes</p> <p>no</p>	<p>The current state of manual control can be transmitted to the bus via a separate status object, if bus voltage is available (setting: "yes").</p>
Status object function and polarity	<p>0 = inactive; 1 = manual control active</p> <p>0 = inactive; 1 = permanent manual control active</p>	<p>This parameter defines the information contained in the status object. The object is always "0", when the manual control mode is deactivated.</p> <p>The object is "1" when the manual control mode is active (temporary or permanent).</p> <p>The object is "1" only when the permanent manual control is active.</p> <p><input type="checkbox"/> This parameter is visible only if the manual control status transmission is enabled.</p> <p><input type="checkbox"/> The status will be actively transmitted to the bus ("0") after bus voltage return only if a manual control was terminated by such return of voltage.</p>

Behaviour at the end of permanent manual control during bus operation

no change

The behaviour of the actuator at the end of permanent manual control depends on this parameter.

All telegrams received during an active permanent manual control mode for direct operation (long-time/short-time, positioning, scenes) are be rejected. After the end of the permanent manual control mode, the current state of all outputs remains unchanged. If, however, a function with a higher priority is being activated during manual control (safety, forced position, sun protection), the actuator activates the higher-ranking function for the corresponding outputs.

output tracking

During an active permanent manual control all incoming telegrams (short-time telegrams excepted) are internally tracked. At the end of manual control, the outputs are adjusted accordingly.

Disable bus control of individual outputs during bus operation? **yes**
no

Individual outputs can be disabled locally during permanent manual control so that the disabled outputs can no longer be controlled via the bus. Disabling by means of manual control is only permitted if this parameter is set to "yes"

 Selection switching – shutter mode

Function Output 1 and output 2	1 x shutter output 2 x switching output	This parameter selects the channel definition of combined outputs A1 and A2.
Function Output 3 and output 4	1 x shutter output 2 x switching output	This parameter selects the channel definition of combined outputs A3 and A4.
Function Output 5 and output 6	1 x shutter output 2 x switching output	This parameter selects the channel definition of combined outputs A5 and A6.
Function Output 7 and output 8	1 x shutter output 2 x switching output	This parameter selects the channel definition of combined outputs A7 and A8.
Function Output 9 and output 10 *	1 x shutter output 2 x switching output	This parameter selects the channel definition of combined outputs A9 and A10.
Function Output 11 and output 12 *	1 x shutter output 2 x switching output	This parameter selects the channel definition of combined outputs A11 and A12.
Function Output 13 and output 14 *	1 x shutter output 2 x switching output	This parameter selects the channel definition of combined outputs A13 and A14.
Function Output 15 and output 16 *	1 x shutter output 2 x switching output	This parameter selects the channel definition of combined outputs A15 and A16.

*: Only at
switching/shutter
actuator 8/16fold

 Ax – General (x = number of output 1/2 ... max. 15/16. / All outputs can be parameterized independently / Only visible in shutter mode!)

Mode of operation (to be adjusted first!)	<p>blind</p> <p>shutter / awning</p> <p>venting louver</p>	<p>The shutter actuator can be used to control different drive systems. This parameter defines which type of drive or which type of curtain is connected to the output.</p> <p>i The ETS adapts all of the following parameters (designations, visible/non visible, etc.) dynamically to the respective mode of operation parameter. For this reason, the "Mode of operation" parameter should be adjusted before all other parameters of an output.</p>
Behaviour after ETS programming	<p>raising / opening the louver</p> <p>lowering / closing the louver</p> <p>stop</p>	<p>The actuator permits setting the preferred relay contact position after ETS programming separately for each output.</p> <p>After programming with the ETS, the actuator raises the curtain or opens the venting louver.</p> <p>After programming with the ETS, the actuator lowers the curtain or closes the venting louver.</p> <p>After programming with the ETS, the actuator switches the relays of the output to the "stop" position. A travel movement in progress, if any, will be interrupted.</p> <p>i The parameterized behaviour will be executed after every application or parameter download by the ETS. A simple download of the physical address alone or partial programming of only the group addresses has the effect that this parameter is disregarded and that the parameterized "Behaviour after bus/mains voltage return" will be executed instead.</p>

Behaviour in case of bus voltage failure:		The actuator permits setting the preferred relay contact position in case of bus voltage failure separately for each output.
	stop	In case of bus voltage failure, the actuator switches the relays of the output to the "stop" position. A travel movement in progress, if any, will be interrupted.
	raising / opening the louver	After bus voltage failure, the actuator raises the curtain or opens the venting louver.
	lowering / closing the louver	After bus voltage failure, the actuator lowers the curtain or closes the venting louver.
	approaching a position	In case of bus voltage failure, the connected drive can approach a position specified by further parameters.
	no reaction	In the event of bus voltage failure, the relay of the output shows no reaction. Any travel movements still in progress at the time of failure will be completely finished . <input type="checkbox"/> The parameterized behaviour will only be executed, if no manual control is activated.
Position of blind during bus voltage failure (0...100%)	0...100	This parameter specifies the blind position to be approached in case of bus voltage failure. <input type="checkbox"/> This parameter is only visible, if "Behaviour in case of bus voltage failure" is set to "approach position". <input type="checkbox"/> This parameter is visible only in the 'Blind' mode of operation.
Position of slat during bus voltage failure (0...100%)	0...100	This parameter specifies the slat position to be approached in case of bus voltage failure after the blind has been positioned at the desired height. <input type="checkbox"/> This parameter is only visible, if "Behaviour in case of bus voltage failure" is set to "approach position". <input type="checkbox"/> This parameter is visible only in the 'Blind' mode of operation.

Position of shutter/awning during bus voltage failure (0...100 %) **0...100**

This parameter specifies the shutter or awning position to be approached in case of bus voltage failure.

- This parameter is only visible, if "Behaviour in case of bus voltage failure" is set to "approach position".
- This parameter is visible only in the 'Shutter/awning' mode of operation.

Position of venting louver during bus voltage failure (0...100 %) **0...100**

This parameter specifies the venting louver position to be approached in case of bus voltage failure.

- This parameter is only visible, if "Behaviour in case of bus voltage failure" is set to "approach position".
- This parameter is visible only in the 'Venting louver' mode of operation.

Behaviour after bus or mains voltage return		The actuator permits setting the preferred relay contact position after mains voltage return separately for each output. This means that the parameterized behaviour is executed when either the bus or the mains voltage is switched on again.
	stop	In case of bus or mains voltage return, the actuator switches the relays of the output to the "stop" position. A travel movement in progress, if any, will be interrupted.
	raising / opening the louver	After bus or mains voltage return, the actuator raises the curtain or opens the venting louver.
	lowering / closing the louver	After bus or mains voltage return, the actuator lowers the curtain or closes the venting louver.
	position during bus/mains failure	After bus or mains voltage return, the state last existing and internally stored <u>before</u> bus or mains voltage failure will be tracked.
	approaching a position	In case of bus or mains voltage return, the connected drive can approach a position specified by further parameters.
	no reaction	In the event of bus or mains voltage return, the relay of the output shows no reaction. Any travel movements still in progress at the time of failure will be completely finished . The reactions active at the time of mains failure are re-executed on return of the mains supply. Interrupted short- or long-time travel movements are restarted at full length and position approaches are continued from the point of interruption. i The parameterized behaviour will only be adopted, if no forced position is activated after bus voltage return.
Position of blind on return of bus/mains voltage (0...100 %)	0...100	This parameter specifies the blind position to be approached in case of bus or mains voltage return. i This parameter is only visible, if "Behaviour in case of bus or mains voltage return" is set to "approach position". i This parameter is visible only in the 'Blind' mode of operation.

Position of slat on return of bus/mains voltage (0...100 %) **0...100**

This parameter specifies the slat position to be approached in case of bus or mains voltage return after the blind has been positioned at the desired height.

- This parameter is only visible, if "Behaviour in case of bus or mains voltage return" is set to "approach position".
- This parameter is visible only in the 'Blind' mode of operation.

Position of shutter/awning on return of bus/mains voltage (0...100%) **0...100**

This parameter specifies the shutter or awning position to be approached in case of bus or mains voltage return.

- This parameter is only visible, if "Behaviour in case of bus or mains voltage return" is set to "approach position".
- This parameter is visible only in the 'Shutter/awning' mode of operation.

Position of venting louver on return of bus/mains voltage (0...100%) **0...100**

This parameter specifies the venting louver position to be approached in case of bus or mains voltage return.

- This parameter is only visible, if "Behaviour in case of bus or mains voltage return" is set to "approach position".
- This parameter is visible only in the 'Venting louver' mode of operation.

Travelling time extension for upward travel **none**
2 %
3 %
4 %
5 %
6 %
7 %
8 %
9 %
10 %
12.5 %

The switching/shutter actuator prolongs all upward movements or venting louver movements into the open position based on the time extension specified in this parameter. The time extension expressed in percent is the difference between the measured travel time needed to reach the lower end position (completely closed position) and the time needed to reach the upper end position (completely open position).

- This parameter is only visible, when the automatic end position detection is not deactivated.

 Ax – Time settings (x = number of output 1/2 ... max. 15/16. / All outputs can be parameterized independently / Only visible in shutter mode!)

Short-time operation		This parameter can be used to parameterize the reaction to a received short-time telegram.
	no (only stop)	The drive will only be stopped if it is executing a travel movement at the time of telegram reception. There is no reaction if no travel movement is in progress.
	yes	Short-time operation is started on reception of a short-time telegram when the drive is stationary. If the drive is in motion at the time of telegram reception, it will be stopped.
Duration of short-time operation Seconds (0...59)	0...59	This parameter defines the duration of short-time operation. Sets the monitoring time seconds.
Milliseconds (0...99 x 10)	0...50...99	Sets the monitoring time milliseconds. <i>Presetting: 2 seconds</i> <input type="checkbox"/> The duration of short-time operation should in no case exceed half the slat adjusting time. <input type="checkbox"/> This parameter is only visible, if the parameter "Short-time operation" is set to "yes".
Blind travelling time Minutes (0...59)	0...1...59	This parameter defines the travelling time of the blind. The time needed for a complete travel from the upper into the lower end position must be determined. Sets the minutes of the blind travelling time.

Seconds (0...59)	0...59	Sets the seconds of the blind travelling time. <i>Presetting: 1 minute</i> <input type="checkbox"/> The travelling time must be determined precisely. <input type="checkbox"/> The travelling time parameters are only visible when the automatic end position detection is not enabled. <input type="checkbox"/> These parameters are visible only in the 'Blind' mode of operation.
Shutter/awning travelling time Minutes (0...59)	0...1...59	This parameter defines the travelling time of the shutter or awning. The time needed for a complete travel from the upper into the lower end position must be determined. Sets the minutes of the shutter or awning travelling time.
Seconds (0...59)	0...59	Sets the minutes of the shutter or awning travelling time. <i>Presetting: 1 minute</i> <input type="checkbox"/> The travelling time must be determined precisely. <input type="checkbox"/> The travelling time parameters are only visible when the automatic end position detection is not enabled. <input type="checkbox"/> These parameters are visible only in the 'Shutter/awning' mode of operation.
Venting louver travelling time Minutes (0...59)	0...1...59	This parameter defines the travelling time of the venting louver. The time needed for a complete travel from the completely open into the completely closed position must be determined. Sets the minutes of the venting louver travelling time.

Seconds (0...59)	0...59	<p>Sets the seconds of the venting louver travelling time.</p> <p><i>Presetting: 1 minute</i></p> <ul style="list-style-type: none"> <input type="checkbox"/> The travelling time must be determined precisely . <input type="checkbox"/> The travelling time parameters are only visible when the automatic end position detection is not enabled. <input type="checkbox"/> These parameters are visible only in the 'Venting louver' mode of operation.
Slat moving time Minutes (0...59)	0...59	<p>This parameter defines the travelling time of the slats. The time needed for a complete travel movement from the completely open slat position into the completely closed slat position (downward direction) must be determined.</p> <p>Sets the minutes of the slat moving time.</p>
Seconds (0...59)	0...4...59	<p>Sets the seconds of the slat moving time.</p> <p><i>Presetting: 4 seconds</i></p> <ul style="list-style-type: none"> <input type="checkbox"/> The moving time must be precisely determined. <input type="checkbox"/> The slat moving time must be selected shorter than the blind travelling time. <input type="checkbox"/> These parameters are visible only in the 'Blind' mode of operation.
Change-over time for travel direction changes	0.5 s 1 s 2 s 5 s	<p>Defines the break during a change of travel direction (change-over time).</p>

 Ax – Enabled functions (x = number of output 1/2 ... max. 15/16. / All outputs can be parameterized independently / Only visible in shutter mode!)

Feedback functions	disabled enabled	This parameter can be used to disable or to enable the feedback functions. When the function is enabled, the required parameters will be displayed under "Ax – Feedbacks".
Safety functions	disabled enabled	This parameter can be used disable or to enable the safety functions. When the function is enabled, the corresponding parameters will be displayed under "Ax – Safety" and the necessary objects enabled.
Sun protection functions	disabled enabled	This parameter can be used disable or to enable the sun protection functions. When the function is enabled, the corresponding parameters will be displayed under "Ax - Sun protection" (3 parameter nodes) and the necessary objects enabled.
Scene function (only in ETS3.0d and onwards)	disabled enabled	This parameter can be used disable or to enable the scene function. When the function is enabled, the corresponding parameters will be displayed under "Ax - Scenes" and the necessary object enabled.
Forced position function (only in ETS3.0d and onwards)	disabled enabled	This parameter can be used disable or to enable the forced position function. When the function is enabled, the corresponding parameters will be displayed under "Ax – Forced position" and the necessary object enabled.
Fabric-stretching function	disabled enabled	This parameter can be used disable or to enable the fabric-stretching function. When the function is enabled, the corresponding parameters will be displayed under "Ax - Fabric-stretching" and the necessary object enabled.  This parameter is visible only in the 'Shutter/awning' mode of operation.

Assignment to central
function ?

This parameter determines the assignment
of the output to the central function.

yes (enable central function
under "General")

The output is assigned to the central
function. The central function is supposed
to have been enabled under "General". The
assignment has otherwise no effect on the
shutter output.

no

The output is not assigned to the central
function.

 Ax – Feedbacks (x = number of output 1/2 ... max. 15/16. / All outputs can be parameterized independently / Only visible in shutter mode and if parameter "Feedback functions ?" under "Ax – Enabled functions" is set to "enabled"!)

Blind position feedback		The current blind position of the output can be reported separately back to the bus.
	no feedback	No feedback object available for the output. Feedback deactivated.
	feedback object is active signalling object	Feedback and object are activated. The object transmits actively (telegram transmission after change).
	feedback object is passive status object	Feedback and object are activated. The object is passive (telegram transmission only as a response to 'Read' request. <input type="checkbox"/> The communication flags of the object are automatically set by the ETS according to the setting. <input type="checkbox"/> This parameter is visible only in the 'Blind' mode of operation.
Shutter/awning position feedback		The current shutter or awning position of the output can be reported separately back to the bus.
	no feedback	No feedback object available for the output. Feedback deactivated.
	feedback object is active signalling object	Feedback and object are activated. The object transmits actively (telegram transmission after change).
	feedback object is passive status object	Feedback and object are activated. The object is passive (telegram transmission only as a response to 'Read' request. <input type="checkbox"/> The communication flags of the object are automatically set by the ETS according to the setting. <input type="checkbox"/> This parameter is visible only in the 'Shutter/awning' mode of operation.

Venting louver position feedback		The current venting louver position of the output can be reported separately back to the bus.
	no feedback	No feedback object available for the output. Feedback deactivated.
	feedback object is active signalling object	Feedback and object are activated. The object transmits actively (telegram transmission after change).
	feedback object is passive status object	Feedback and object are activated. The object is passive (telegram transmission only as a response to 'Read' request). <input type="checkbox"/> The communication flags of the object are automatically set by the ETS according to the setting. <input type="checkbox"/> This parameter is visible only in the 'Venting louver' mode of operation.
Time delay for feedback after bus voltage return ?	yes (delay time under "General"!) no	The feedback telegram can be transmitted to the bus with a delay after bus voltage return or after programming with the ETS. Setting "yes" activates the feedback delay in case of bus voltage return. The delay time is parameterized under "General". <input type="checkbox"/> This parameter is only visible in case of an actively transmitting feedback object.
Slat position feedback		The current slat position of the output can be reported separately back to the bus.
	no feedback	No feedback object available for the output. Feedback deactivated.
	feedback object is active signalling object	Feedback and object are activated. The object transmits actively (telegram transmission after change).
	feedback object is passive status object	Feedback and object are activated. The object is passive (telegram transmission only as a response to 'Read' request). <input type="checkbox"/> The communication flags of the object are automatically set by the ETS according to the setting. <input type="checkbox"/> This parameter is visible only in the 'Blind' mode of operation.

Time delay for feedback after bus voltage return ?	yes (delay time under "General")	The feedback telegram can be transmitted to the bus with a delay after bus voltage return or after programming with the ETS. Setting "yes" activates the feedback delay in case of bus voltage return. The delay time is parameterized under "General".
	no	<p>ⓘ This parameter is only visible in case of an actively transmitting feedback object.</p>
Invalid blind position feedback	no feedback	<p>The actuator can report to the bus that the current blind position is unknown (e.g. after an initialization, when no reference travel has been executed as yet).</p> <p>No feedback object available for the output. Feedback deactivated.</p>
	feedback object is active signalling object	Feedback and object are activated. The object transmits actively (telegram transmission after change).
	feedback object is passive status object	<p>Feedback and object are activated. The object is passive (telegram transmission only as a response to 'Read' request).</p> <p>ⓘ The communication flags of the object are automatically set by the ETS according to the setting.</p> <p>ⓘ This parameter is visible only in the 'Blind' mode of operation.</p>
Invalid shutter/awning position feedback	no feedback	<p>The actuator can report to the bus that the current shutter/awning position is unknown (e.g. after an initialization, when no reference travel has been executed as yet).</p> <p>No feedback object available for the output. Feedback deactivated.</p>
	feedback object is active signalling object	Feedback and object are activated. The object transmits actively (telegram transmission after change).
	feedback object is passive status object	<p>Feedback and object are activated. The object is passive (telegram transmission only as a response to 'Read' request).</p> <p>ⓘ The communication flags of the object are automatically set by the ETS according to the setting.</p> <p>ⓘ This parameter is visible only in the 'Shutter/awning' mode of operation.</p>

Invalid venting louver
position feedback

The actuator can report to the bus that the current venting louver position is unknown (e.g. after an initialization, when no reference travel has been executed as yet).

no feedback

No feedback object available for the output. Feedback deactivated.

feedback object is active
signalling object

Feedback and object are activated. The object transmits actively (telegram transmission after change).

feedback object is passive
status object

Feedback and object are activated. The object is passive (telegram transmission only as a response to 'Read' request.

The communication flags of the object are automatically set by the ETS according to the setting.

This parameter is visible only in the 'Venting louver' mode of operation.

Time delay for feedback
after bus voltage return ? yes (delay time under
"General")

The feedback telegram can be transmitted to the bus with a delay after bus voltage return or after programming with the ETS. Setting "yes" activates the feedback delay in case of bus voltage return. The delay time is parameterized under "General".

no

This parameter is only visible in case of an actively transmitting feedback object.

Travel movement
feedback

The actuator can report to the bus that the connected drive is active, i.e. the output is supplying power to the drive for a travel direction.

no feedback

No feedback object available for the output. Feedback deactivated.

feedback object is active
signalling object

Feedback and object are activated. The object transmits actively (telegram transmission after change).

feedback object is passive
status object

Feedback and object are activated. The object is passive (telegram transmission only as a response to 'Read' request.

The communication flags of the object are automatically set by the ETS according to the setting.



Time delay for feedback after bus voltage return ? yes (delay time under "General")

no

The feedback telegram can be transmitted to the bus with a delay after bus voltage return or after programming with the ETS. Setting "yes" activates the feedback delay in case of bus voltage return. The delay time is parameterized under "General".

i This parameter is only visible in case of an actively transmitting feedback object.

 Ax – Safety (x = number of output 1/2 ... max. 15/16. / All outputs can be parameterized independently / Only visible in shutter mode and if parameter "Safety functions ?" under "Ax – Enabled functions" is set to "enabled"!)

Assignment to wind alarms	<p>no</p> <p>wind alarm 1</p> <p>wind alarm 2</p> <p>wind alarm 3</p> <p>wind alarm 1 + 2</p> <p>wind alarm 1 + 3</p> <p>wind alarm 2 + 3</p> <p>wind alarm 1 + 2 + 3</p>	<p>This parameter defines whether the output responds to a wind alarm and to which of the alarms.</p>
Behaviour in case of wind alarm	<p>no reaction</p> <p>raising / opening the louver</p> <p>lowering / closing the louver</p> <p>stop</p>	<p>This parameter defines the behaviour of the output at the beginning of a wind alarm.</p> <p>At the beginning of the wind alarm or wind alarms, the output is interlocked and the relay of the output shows no reaction. Any travel movements in progress at this instant will still be completely finished.</p> <p>The actuator raises the curtain or opens the venting louver at the beginning of the wind alarm or wind alarms and locks the output thereafter.</p> <p>The actuator lowers the curtain or closes the venting louver at the beginning of the wind alarm or wind alarms and locks the output thereafter.</p> <p>At the beginning of the wind alarm or wind alarms, the actuator switches the relays of the output to "stop" and locks the output. A travel movement in progress, if any, will be interrupted.</p> <p> The behaviour preset in this parameter will be executed when one of the assigned wind alarms is activated.</p> <p> This parameter is only visible, if the output has been assigned to at least one wind alarm.</p>

Assignment to rain alarm	<p>yes</p> <p>no</p>	<p>This parameter defines whether the output responds to the rain alarm.</p>
Behaviour in case of rain alarm	<p>no reaction</p> <p>raising / opening the louver</p> <p>lowering / closing the louver</p> <p>stop</p>	<p>This parameter defines the behaviour of the output at the beginning of the rain alarm.</p> <p>At the beginning of the rain alarm, the output is interlocked and the relay of the output shows no reaction. Any travel movements in progress at this time will still be completely finished.</p> <p>The actuator raises the curtain or opens the venting louver at the beginning of the rain alarm and locks the output thereafter.</p> <p>The actuator lowers the curtain or closes the venting louver at the beginning of the rain alarm and locks the output thereafter.</p> <p>At the beginning of the rain alarm, the actuator switches the relays of the output to "stop" and locks the output. A travel movement in progress, if any, will be interrupted.</p> <p>i This parameter is only visible, if the output has been assigned to the rain alarm.</p>
Assignment to frost alarm	<p>yes</p> <p>no</p>	<p>This parameter defines whether the output responds to the frost alarm.</p> <p>i An assignment to the alarms is only possible when the safety functions and the alarms themselves are enabled under "Shutter outputs safety".</p>

Behaviour in case of
frost alarm

This parameter defines the behaviour of
the output at the beginning of the frost
alarm.

no reaction

At the beginning of the frost alarm, the
output is interlocked and the relay of the
output shows no reaction. Any travel
movements in progress at this time will still
be completely finished.

raising / opening the louver

The actuator raises the curtain or opens
the venting louver at the beginning of the
frost alarm and locks the output thereafter.

lowering / closing the louver

The actuator lowers the curtain or closes
the venting louver at the beginning of the
frost alarm and locks the output thereafter.

stop

At the beginning of the frost alarm, the
actuator switches the relays of the output to
"stop" and locks the output. A travel
movement in progress, if any, will be
interrupted.

i This parameter is only visible, if the
output has been assigned to the frost
alarm.

Behaviour at the end of
safety
(wind, rain, frost)

	This parameter defines the behaviour of the output at the end of all safety functions.
no reaction	At the end of the safety functions, the output is unlocked and the relay of the output shows no reaction. Any travel movements still in progress at this time will still be finished.
raising / opening the louver	The actuator unlocks the output at the end of all safety alarms and raises the curtain or opens the venting louver.
lowering / closing the louver	The actuator unlocks the output at the end of the safety functions and lowers the curtain or closes the venting louver.
stop	At the end of the safety functions, the output is unlocked and the actuator switches the relays of the output into the "stop" position. A travel movement in progress, if any, will be interrupted.
tracking the position	<p>At the end of safety, the output will be set to the state last adjusted before the safety function or to the state tracked and internally stored during the safety function. The position objects, the long-time object and the scene function are tracked.</p> <p>i The behaviour preset in this parameter will only be executed, if the output passes over to direct operation at the end of safety. Direct operation will be executed when a sun protection function is active.</p>

 Ax – Sun protection (x = number of output 1/2 ... max. 15/16. / All outputs can be parameterized independently / Only visible in shutter mode and if parameter "Sun protection function?" under "Ax – Enabled functions" is set to "enabled"!)

Priority of sun protection with respect to direct operation

this parameter defines the priority of the sun protection function with respect to direct operation

same priority

The sun protection can be overridden by direct operation and vice versa. Only after the next reception of a "sun is shining" signal will the sun protection mode be activated again.

higher priority

The sun protection has the higher priority and cannot be aborted by a direct operation.

lower priority

The direct operation has the higher priority and cannot be aborted by a sun protection. The sun protection can be activated only after an enabling travel into the upper end position initiated by a direct operation has occurred without interruption .

 Direct operation = long-time/short-time operation; positioning via objects, scenes, central control.

 This parameter is only visible in the simple sun protection.

Polarity of the "Sunshine / shading facade" object **sunshine = 1;**
no sunshine = 0

This parameter defines the polarity of the input object "Sunshine / shading facade" of the sun protection.

sunshine = 0;
no sunshine = 1

 Ax – Beginning of sun protection (x = number of output 1/2 ... max. 15/16. / All outputs can be parameterized independently / Only visible in shutter mode and if parameter "Sun protection function?" under "Ax – Enabled functions" is set to "enabled"!)

Time delay beginning of
sunshine / shading **0**...59
Minutes (0...59)

The telegram received via the object "Sunshine / shading facade " for activation or deactivation of shading (depending on polarity) can be evaluated with a time delay.

Sets the minutes of the delay time.

Seconds (0...59) 0...**30**...59

Sets the delay time seconds.

Presetting: 30 seconds

 A time setting of "0" in the parameters deactivates the respective delay time. In this case, the state of shading is evaluated immediately.

Reaction at the beginning of sunshine / shading		This parameter defines the behaviour of the output at the beginning of shading – if applicable, after the end of the delay time.
	no reaction	At the beginning of shading, the output switches over to sun protection while the relays of the output show no reaction. Any travel movements still in progress at this time will still be finished.
	raising	At the beginning of shading, the actuator raises the curtain.
	lowering	At the beginning of shading, the actuator lowers the curtain.
	stop	At the beginning of shading, the actuator switches the relays of the output to the "stop" position. A travel movement in progress, if any, will be interrupted.
	internal scene recall	At the beginning of shading, the shutter actuator recalls the position values preset in the scene configuration for the output concerned. This is not a scene recall as in direct operation, but only an approach of the corresponding scene position values.
	blind or slat position fixed	At the beginning of shading, the output controls the approach to a parameterized fixed blind and slat position.
	blind position fixed / slat position variable	At the beginning of shading, the output controls the approach to a parameterized fixed blind position and to slat position preset by a separate object and thus variable.
	slat position fixed / variable blind position variable	At the beginning of shading, the output controls the approach to a parameterized fixed slat position and to a blind position preset by a separate object and thus variable.
	blind and slat position variable	At the beginning of shading, the output controls the approach to the blind and slat positions preset by two separate objects and thus variable.
		i This parameter is visible only in the 'Blind' mode of operation.

Reaction at the
beginning of sunshine /
shading

no reaction

This parameter defines the behaviour of the output at the beginning of shading – if applicable, after the end of the delay time.

At the beginning of shading, the output switches over to sun protection while the relays of the output show no reaction. Any travel movements still in progress at this time will still be finished.

raising

At the beginning of shading, the actuator raises the curtain.

lowering

At the beginning of shading, the actuator lowers the curtain.

stop

At the beginning of shading, the actuator switches the relays of the output to the "stop" position. A travel movement in progress, if any, will be interrupted.

internal scene recall

At the beginning of shading, the shutter actuator recalls the position value preset in the scene configuration for the output concerned. This is not a scene recall as in direct operation, but only an approach to the corresponding scene position value.

**shutter / awning position
fixed**

At the beginning of shading, the output controls the approach to a parameterized fixed shutter / awning position.

shutter / awning position
variable

At the beginning of shading, the output controls the approach to the shutter / awning position preset by a separate object and thus variable.

i This parameter is visible only in the "Shutter / awning" mode of operation.

Reaction at the beginning of sunshine / shading		This parameter defines the behaviour of the output at the beginning of shading – if applicable, after the end of the delay time.
	no reaction	At the beginning of shading, the output switches over to sun protection while the relays of the output show no reaction. Any travel movements still in progress at this time will still be finished.
	opening the louver	At the beginning of shading, the actuator opens the venting louver.
	closing the louver	At the beginning of shading, the actuator closes the venting louver.
	stop	At the beginning of shading, the actuator switches the relays of the output to the "stop" position. A travel movement in progress, if any, will be interrupted.
	internal scene recall	At the beginning of shading, the shutter actuator recalls the position value preset in the scene configuration for the output concerned. This is not a scene recall as in direct operation, but only an approach to the corresponding scene position value.
	venting louver position fixed	At the beginning of shading, the output controls the approach to a parameterized fixed venting louver position.
	venting louver position variable	At the beginning of shading, the output controls the approach to the venting louver position preset by a separate object and thus variable. <i>i</i> This parameter is visible only in the "Venting louver" mode of operation.
Scene number (1...8)	1...8	This parameter defines the number of the internal scene which is recalled at the beginning of shading. <i>i</i> This parameter is only visible, if the parameter "Reaction at the beginning of sunshine / shading" is set to "internal scene recall".

Fixed position of blind		<p>The fixed blind position at the beginning of shading can either be preset statically by a separate parameter or basically adjusted to the value prevailing at the time of shading activation, i.e. remain unchanged.</p>
	as specified by parameter	<p>At the beginning of shading, the parameterized blind position will be approached.</p>
	no change in current position	<p>At the beginning of shading, the current position of the blind will be maintained. In this case, the output behaves as if only the slat were positioned as a result of shading.</p> <p><input type="checkbox"/> This parameter is only visible, if the blind is to approach a fixed position at the beginning of shading.</p> <p><input type="checkbox"/> This parameter is visible only in the 'Blind' mode of operation.</p>
Position of blind (0...100 %)	0... 50 ...100	<p>This parameter sets the fixed position of the blind to be approached at the beginning of shading.</p> <p><input type="checkbox"/> This parameter is only visible, if the parameter "Fixed position of blind" is set to "as specified by parameter".</p> <p><input type="checkbox"/> This parameter is visible only in the 'Blind' mode of operation.</p>
Fixed position of slat (0...100 %)	0... 50 ...100	<p>This parameter sets the fixed position of the slat to be approached at the beginning of shading and, as the case may be, after positioning of the blind.</p> <p><input type="checkbox"/> This parameter is only visible, if the slat is to approach a fixed position at the beginning of shading.</p> <p><input type="checkbox"/> This parameter is visible only in the 'Blind' mode of operation.</p>

Fixed position of shutter / awning		The fixed position of the shutter or awning at the beginning of shading can either be preset statically by a separate parameter or basically adjusted to the value prevailing at the time of shading activation, i.e. remain unchanged.
	as specified by parameter	At the beginning of shading, the parameterized shutter / awning position will be approached.
	no change in current position	<p>At the beginning of shading, the current position of the shutter or awning will be maintained. Any travel movements in progress at the time of shading activation will be finished.</p> <p><input type="checkbox"/> This parameter is only visible, if the shutter or awning is to approach a fixed position at the beginning of shading.</p> <p><input type="checkbox"/> This parameter is visible only in the "Shutter / awning" mode of operation.</p>
Position of shutter / awning (0...100 %)	0... 50 ...100	<p>This parameter sets the fixed position of the shutter or awning to be approached at the beginning of shading.</p> <p><input type="checkbox"/> This parameter is only visible, if the parameter "Fixed position of shutter / awning" is set to "as specified by parameter".</p> <p><input type="checkbox"/> This parameter is visible only in the "Shutter / awning" mode of operation.</p>
Fixed position of venting louver		The fixed venting louver position at the beginning of shading can either be preset statically by a separate parameter or basically adjusted to the value prevailing at the time of shading activation, i.e. remain unchanged.
	as specified by parameter	At the beginning of shading, the parameterized venting louver position will be approached.
	no change in current position	<p>At the beginning of shading, the current position of the venting louver will be maintained. Any travel movements in progress at the time of shading activation will be finished.</p> <p><input type="checkbox"/> This parameter is only visible, if the venting louver is to approach a fixed position at the beginning of shading.</p> <p><input type="checkbox"/> This parameter is visible only in the "Venting louver" mode of operation.</p>

Offset slat position -100...0...100
(-100..100 %)

This parameter is used for setting the slat offset. The value specified in this parameter is added at the beginning of shading to the current slat angle.

- i Even with offset correction, the 0...100% slat position limits cannot be overstepped.
- i It should be noted that the parameterized offset value can be overwritten by the object after reception of a dynamical value.
- i This parameter is only visible, if the parameter "Offset with fixed and variable slat position" is set to "Offset as parameterized" or to "Offset as parameterized and via object".
- i This parameter is visible only in the 'Blind' mode of operation.

Store offset slat position
in case of bus/mains
voltage failure ?

If the offset is preset via the object, this parameter defines whether the received value is to be stored in the actuator's NV memory.

yes



The value received via the object will be stored in case of bus or mains voltage failure in the non-volatile memory of the actuator. The originally parameterized offset value is definitely overwritten in the process.

no



The value received via the object will only be stored temporarily in a volatile memory. Thus, the value received via the object replaces the parameterized value only until the actuator is re-initialized (return of bus or mains voltage, if both voltages were off beforehand). After the initialization, the offset value parameterized in the ETS will be used again.

- i This parameter is only visible, if the parameter "Offset with fixed and variable slat position" is set to "offset as parameterized and via object".
- i This parameter is visible only in the 'Blind' mode of operation.

 Ax – End of sun protection (x = number of output 1/2 ... max. 15/16. / All outputs can be parameterized independently / Only visible in shutter mode and if parameter "Sun protection function?" under "Ax – Enabled functions" is set to "enabled!")

Time delay end of sunshine / shading Minutes (0...59)	0...59	The telegram received via the object "Sunshine / shading facade " for the deactivation of shading (depending on polarity) can be evaluated with a time delay. Sets the minutes of the delay time.
Seconds (0...59)	0... 30 ...59	Sets the delay time seconds. <i>Presetting: 30 seconds</i>  A time setting of "0" in the parameters deactivates the respective delay time. In this case, the state of shading is evaluated immediately.
Reaction at the end of sunshine / shading	no reaction	This parameter defines the behaviour of the output at the end of shading – if applicable, after the end of the delay time. At the end of shading, the output quits the sun protection mode and the relays of the output show no reaction. Any travel movements in progress at this time will still be finished.
	raising / opening the louver	At the end of shading, the actuator raises the curtain or opens the venting louver.
	lowering / closing the louver	At the end of shading, the actuator lowers the curtain or closes the venting louver.
	stop	At the end of shading, the actuator switches the relays of the output to the "stop" position. A travel movement in progress, if any, will be interrupted.
	tracking the position	At the end of shading, the output will be set to the state last adjusted before sun protection or to the state tracked and internally stored during sun protection. The position objects, the long-time object and the scene function are tracked.  The behaviour preset in this parameter will only be executed, if no function with a higher priority (e.g. safety) is activated at the time of shading.

 Ax – Scenes (x = number of output 1/2 ... max. 15/16. / All outputs can be parameterized independently / Only visible in shutter mode and if parameter "Scene function ?" under "Ax – Enabled functions" is set to "enabled"! / Only in ETS3.0d and onwards!)

Delay scene recall ?	yes no	A scene is recalled via the scene extension object. If needed, the scene recall on the actuator can be made with a delay after reception of a recall telegram (setting: "yes"). The recall is alternatively made immediately on reception of the telegram (setting: "no").  A recall delay has no influence on the storage of scene values.
Delay time Minutes (0...59)	0...59	This parameter is used for programming the duration of the delaytime for a scene recall. Sets the delaytime minutes.
Seconds (0...59)	0... 10 ...59	Sets the delaytime seconds. <i>Presetting: 10 seconds</i>  The delay time parameters are only visible, if the parameter "Delay scene recall ?" is set to "yes".
Overwrite values stored in the device during an ETS download ?	yes no	During storage of a scene, the scene values (current states of the outputs concerned) are stored internally in the device. To prevent the stored values from being replaced during an ETS programming operation by the originally programmed scene states, the actuator can inhibit overwriting of the scene values (setting: "no"). As an alternative, the original values can be reloaded into the device during each ETS programming operation (setting: "yes").
Scene X activatable by scene number (scene number "0" = scene deactivated) <i>X = depending on the scene (1...8)</i>	0...1...64 <i>*: The predefined scene number is dependent on the scene (1...8).</i>	The actuator distinguishes between up to 8 different scenes which are recalled via the scene extension object or stored. The datapoint type of the extension object, however, permits addressing a maximum of 64 scenes. This parameter defines the scene number (1...64) which is used to address the internal scene (1...8). A setting of "0" deactivates the corresponding scene.

<p>Position of blind for scene X</p> <p><i>X = depending on the scene (1...8)</i></p>	<p>0*...100</p> <p><i>*: The predefined position value is dependent on the scene (1...8).</i></p>	<p>This parameter is used for parameterizing the blind position which is executed when the scene is recalled.</p> <p><input type="checkbox"/> This parameter is visible only in the 'Blind' mode of operation.</p>
<p>Position of slat for scene X</p> <p><i>X = depending on the scene (1...8)</i></p>	<p>0*...100</p> <p><i>*: The predefined position value is dependent on the scene (1...8).</i></p>	<p>This parameter is used for parameterizing the slat position which is executed when the scene is recalled.</p> <p><input type="checkbox"/> This parameter is visible only in the 'Blind' mode of operation.</p>
<p>Position of shutter/awning for scene X</p> <p><i>X = depending on the scene (1...8)</i></p>	<p>0*...100</p> <p><i>*: The predefined position value is dependent on the scene (1...8).</i></p>	<p>This parameter is used for parameterizing the shutter or awning position which is executed when the scene is recalled.</p> <p><input type="checkbox"/> This parameter is visible only in the "Shutter/awning" mode of operation.</p>
<p>Position of venting louver for scene X</p> <p><i>X = depending on the scene (1...8)</i></p>	<p>0*...100</p> <p><i>*: The predefined position value is dependent on the scene (1...8).</i></p>	<p>This parameter is used for parameterizing the venting louver position which is executed when the scene is recalled.</p> <p><input type="checkbox"/> This parameter is visible only in the "Venting louver" mode of operation.</p>
<p>Storage function for scene X</p> <p><i>X = depending on the scene (1...8)</i></p>	<p>yes</p> <p>no</p>	<p>Setting "yes" enables the storage function of the scene. If the function is enabled, the current position (0...100 %) can be stored internally via the extension object on reception of a storage telegram. If "no" is selected, the storage telegrams are rejected.</p>

 Ax – Forced position (x = number of output 1/2 ... max. 15/16. / All outputs can be parameterized independently / Only visible in shutter mode and if parameter "Forced-position function ?" under "Ax – Enabled functions" is set to "enabled"! / Only in ETS3.0d and onwards!)

Behaviour at the end of the forced-position function

The behaviour of the output at the beginning of a forced-position function is directly determined by the forced-position telegram. The behaviour of the output at the end of the forced-position function can be parameterized.

tracking the position

At the end of the forced-position state, the output will be set to the position last existing before the forced-position function or to the one tracked internally while the forced-position function was active.

no change

At the end of forced-position state, the position last adjusted will not be changed. Thereafter, the output is again enabled.

Behaviour after bus voltage return

The communication object of the forced position function can be initialized after bus voltage return.

no forced position active

After bus voltage return, the forced position function is deactivated.

forced position on, raising / opening the louver

The forced-position function is activated after bus voltage return and the curtain raised or the venting louver opened.

forced position on, lowering / closing the louver

The forced-position function is activated after bus voltage return and the curtain lowered or the venting louver closed.

state of forced position before bus/mains voltage failure

After bus voltage return, the forced-position state last selected and internally stored before bus or mains voltage failure will be tracked. An ETS programming operation deletes the stored state (reaction in that case same as with "no forced position active").

 This parameter is evaluated even after an ETS download of the application or of parameters.

 The forced-position parameters are only visible, if the parameter "Forced-position function" under "Ax - Enabled functions" is set to "enabled".

 Ax – Fabric-stretching (x = number of output 1/2 ... max. 15/16. / All outputs can be parameterized independently / Only visible in shutter mode and if parameter "Fabric-stretching function ?" under "Ax – Enabled functions" is set to "enabled"!)

Time for fabric-stretching 0...**1**...59
Seconds (0...59)

This parameter is used to define the duration of the fabric-stretching movement.

Sets the seconds of the fabric-stretching movement.

Milliseconds 0...**9**
(0...9 x 100)

Sets the milliseconds of the fabric-stretching movement.

Presetting: 1 second

 The time for the fabric-stretching movement must be selected shorter than the travelling time of the shutter/awning!

 Ax – General (x = number of output 1 ... max. 16. / All outputs can be parameterized independently / Only visible in switching mode!)

Mode of operation

The relays of a switching output can be parameterized as make or break contacts. This feature offers the possibility of inversion the switching states.

(make contact)

Switching state = off ("0") → relay contact open
Switching state = on ("1") → relay contact closed

break contact

Switching state = off ("0") → relay contact closed
Switching state = on ("1") → relay contact open

Behaviour after ETS programming

The actuator permits setting the preferred relay contact position after ETS programming separately for each output.

close contact

The relay contact is closed after an ETS programming cycle.

open contact

The relay contact is opened after an ETS programming cycle.

no reaction

After ETS programming, the relay of the output shows no response and remains in the switching state last selected.

 The parameterized behaviour will be executed after every application or parameter download by the ETS. A simple download of the physical address alone or partial programming of only the group addresses has the effect that this parameter is disregarded and that the parameterized "Behaviour after bus voltage return" will be executed

Behaviour in case of bus
voltage failure

The actuator permits setting the preferred
relay contact position in case of bus
voltage failure separately for each output.

close contact

The relay contact is closed on bus voltage
failure.

open contact

The relay contact is opened on bus voltage
failure.

no reaction

In case of bus voltage failure, the relay of
the output shows no reaction and remains
in the switching state last selected.

Behaviour after bus or mains voltage return		The actuator permits setting the preferred relay contact position after bus voltage return separately for each output.
	close contact	The relay contact is closed after bus voltage return.
	open contact	The relay contact is opened after bus voltage return.
	state as before bus voltage failure	After bus voltage return, the switching state last selected before bus voltage failure and internally stored on bus voltage failure will be retained.
	activate staircase function (if parameterized)	The staircase lighting function is activated after bus voltage return independent of the "Switching" object. For this setting it is indispensable that the staircase lighting function has been programmed and enabled beforehand. When the staircase function has not been enabled, this setting will produce no reaction after return of the bus voltage.
		<ul style="list-style-type: none"> i Setting "state as before bus/mains voltage failure": an ETS application or parameter download resets the internally stored switching state to "off – 0". i The device adopts the parameterized behaviour only if the last ETS programming of the application or of the parameters ended at least ca. 20 s ago. Otherwise ($T_{ETS} < 20$ s), the "Behaviour after ETS programming" will be adopted also in case of bus voltage return. i The parameterized behaviour will only be adopted, if no forced control is activated after bus voltage return.
Assignment to central function ?		This parameter determines the assignment of the output to the central function.
	yes (enable central function under "General")	The output is assigned to the central function. The central function is supposed to have been enabled under "General". The assignment has otherwise no effect on the switching output.
	no	The output is not assigned to the central function.

Feedback telegram ?		The current switching state of the output can be reported back separately to the bus.
	none	No feedback object available for the output. Feedback deactivated.
	no inversion, active message object	Feedback and object are activated. The state is transmitted in non-inverted form. The object transmits actively.
	no inversion, passive status object	Feedback and object are activated. The state is transmitted in non-inverted form. The object is passive (telegram transmission only as a response to 'Read' request).
	inversion, active message object	Feedback and object are activated. The state is transmitted in inverted form. The object transmits actively.
	inversion, passive status object	Feedback and object are activated. The state is transmitted in inverted form. The object is passive (telegram transmission only as a response to 'Read' request).
		<input type="checkbox"/> The communication flags of the object are automatically set by the ETS according to the setting.
Time delay for feedback telegram after bus voltage return ?	yes (delay time under "General")	The feedback telegram can be transmitted to the bus with a delay after bus voltage return or after programming with the ETS. Setting "Yes" activates the delay time of the feedback in case of bus voltage return. The delay time is parameterized under "General".
	no	<input type="checkbox"/> This parameter is visible as an active message object only if feedback is enabled.

Cyclical transmission of
feedback telegram ?

yes (transm. cyclic and in
case of changes)

The object value of the feedback can be
transmitted cyclically.

The feedback telegram is transmitted to the
bus cyclically and after state changes.
The cycle time is generally programmed
under the "Time settings" entry for all
feedback telegrams.

**no (transmission only in
case of changes)**

The feedback telegram is transmitted to the
bus only after state changes.

This parameter is visible as an active
message object only if feedback is
enabled.

 Ax – Enabled functions (x = number of output 1 ... max. 16. / All outputs can be parameterized independently / Only visible in switching mode!)

Time delays	disabled enabled	This parameter can be used to disable or to enable the time delays. When the function is enabled, the corresponding parameters will be displayed under "Ax - Time delays"
Staircase function	disabled enabled	This parameter can be used to disable or to enable the staircase function. When the function is enabled, the corresponding parameters will be displayed under "Ax - Staircase function" and the necessary object enabled.
Scene function (only in ETS3.0d and onwards)	disabled enabled	This parameter can be used to disable or to enable the scene function. When the function is enabled, the corresponding parameters will be displayed under "Ax - Scenes" and the necessary object enabled.

 Ax – Time delays (x = number of output 1 ... max. 16. / All outputs can be parameterized independently / Only visible in switching mode and if parameter "Time delays" under "Ax – Enabled functions" is set to "enabled"!)

Selection of time delay	<p>no time delay</p> <p>OFF-delay</p> <p>ON-delay</p> <p>ON-delay and OFF-delay</p>	<p>The communication object "Switching" can be evaluated with a time delay. This parameter selects the desired mode of operation of the time delay and enables the other delay parameters.</p>
ON-delay Hours (0...23)	0...23	<p>This parameter is used for programming the duration of the ON-delay</p> <p>Setting the ON-delay hours.</p>
Minutes (0...59)	0...59	Setting the ON-delay minutes.
Seconds (0...59)	0...30...59	<p>Setting the ON-delay seconds.</p> <p><i>Presetting: 30 seconds</i></p>
ON-delay retriggerable ?	<p>yes</p> <p>no</p>	<p>An active ON-delay can be retriggered by another "1" telegram (setting "yes"). Alternatively, retriggering can be excluded (setting "no").</p> <p> The ON-delay parameters are only visible, if the parameter "Selection of time delay" is set to "ON-delay" or to "ON- and OFF-delay".</p>
OFF-delay Hours (0...23)	0...23	<p>This parameter is used for programming the duration of the OFF-delay</p> <p>Setting the OFF-delay hours.</p>
Minutes (0...59)	0...59	Setting the OFF-delay minutes.
Seconds (0...59)	0...30...59	<p>Setting the OFF-delay seconds.</p> <p><i>Presetting: 30 seconds</i></p>

OFF-delay retriggerable ? yes

no

An active OFF-delay can be retriggered by another "0" telegram (setting "yes"). Alternatively, retriggering can be excluded (setting "no").

i The OFF-delay parameters are only visible, if the parameter "Selection of time delay" is set to "OFF-delay" or to "ON- and OFF-delay".



 Ax – Staircase function (x = number of output 1 ... max. 16. / All outputs can be parameterized independently / Only visible in switching mode and if parameter "Staircase function" under "Ax – Enabled functions" is set to "enabled"!)

Staircase time Hours (0...23)	0...23	This parameter is used for programming the duration of the staircase lighting time. Setting the staircase lighting time hours.
Minutes (0...59)	0...3...59	Setting the staircase lighting time minutes.
Seconds (0...59)	0...59	Setting the staircase lighting time seconds. <i>Presetting:3 minutes</i>
Staircase time retriggerable ?	yes no	An active staircase lighting time can be retriggered (setting "yes"). Alternatively, retriggering can be excluded (setting "no").
Reaction to OFF telegram	switch off ignore	An active staircase lighting time can be stopped prematurely by deactivating the staircase lighting time. The staircase lighting time is stopped after reception of an OFF-telegram to the "Staircase function start/stop" object. In the supplementary function "Time preset via the bus" with the setting "Activate staircase function via 'Staircase time' object ? = Yes", the staircase lighting time can also be stopped prematurely by inserting a factor of "0". OFF-telegrams or factors of "0" will be ignored. The staircase time will be executed completely.

Activate ON-delay for staircase function ?		The staircase function permits activating its own ON-delay. This ON-delay function acts on the trigger event of the staircase function and therefore delays switching on.
	yes	The ON-delay is enabled.
	no	The ON-delay is disabled. i The ON-delay parameterized under this item is independent of the other time functions of the actuator. It only acts on the staircase function and not on the "Switching" object.
ON-delay Hours (0...23)	0...23	This parameter is used for programming the duration of the ON-delay Setting the ON-delay hours.
Minutes (0...59)	0...59	Setting the ON-delay minutes.
Seconds (0...59)	0...30...59	Setting the ON-delay seconds. <i>Presetting: 30 seconds</i>
ON-delay retriggerable ?	yes	An active ON-delay can be retriggered (setting "yes"). Alternatively, retriggering can be excluded (setting "no"). i The ON-delay parameters are only visible, if the parameter "Activate ON-delay for staircase function ?" is set to "yes".
	no	
Activate pre-warning time ?		When the staircase time of a staircase timer function has elapsed, the output can activate the pre-warning function. The pre-warning function is designed to warn a person in the staircase that the lights will go out shortly.
	yes	The pre-warning function is activated.
	no	The pre-warning function is deactivated.





Pre-warning time Minutes (0...59)	0...59	<p>This parameter is used for programming the duration of the pre-warning time. The pre-warning time is added to the staircase lighting time. Pre-warnings (shutting off the output) will be generated only within the pre-warning time.</p> <p>Setting the pre-warning time minutes.</p>
Seconds (0...59)	0... 30 ...59	<p>Setting the pre-warning time seconds.</p> <p><i>Presetting: 30 seconds</i></p> <p>i A pre-warning time is aborted by retriggering of the staircase function.</p>
Number of pre-warnings (1...10)	1... 3 ...10	<p>This parameter defines how often the output is to switch off within the pre-warning time. i.e. how many pre-warnings will be generated.</p>
Time for pre-warning interruptions Seconds (0...59)	0...59	<p>This parameter defines the duration of a pre-warning interruption, i.e. how long the output is to remain off during a pre-warning interruption. The time should be adapted individually to the shut-off behaviour of the lamp type used.</p> <p>Setting the pre-warning interruption seconds.</p>
Milliseconds (0...9 x 100)	0... 5 ...9	<p>Setting the pre-warning interruption milliseconds.</p> <p><i>Presetting: 500 milliseconds</i></p> <p>i It must be ensured that the "Number of pre-warnings" and the "Time for pre-warning interruptions" are coordinated with the length of the total "pre-warning time". Thus, the total shut-off phase during a pre-warning ("Number of pre-warnings" + "Time for pre-warning interruptions") must not be chosen longer than the pre-warning time itself. Otherwise risk of malfunctions.</p>

 Ax – Scenes (x = number of output 1 ... max. 16. / All outputs can be parameterized independently / Only visible in switching mode and if parameter "Scene function" under "Ax – Enabled functions" is set to "enabled"!)

Delay scene recall ?	yes no	<p>A scene is recalled via the scene extension object. If needed, the scene recall on the actuator can be made with a delay after reception of a recall telegram (setting: "yes"). The recall is alternatively made immediately on reception of the telegram (setting: "no").</p> <p> A recall delay has no influence on the storage of scene values.</p>
Delay time Minutes (0...59)	0...59	<p>This parameter is used for programming the duration of delay time</p> <p>Setting the delay time hours.</p>
Seconds (0...59)	0... 10 ...59	<p>Setting the delay time seconds.</p> <p><i>Presetting: 10 seconds</i></p> <p> The parameters are only visible, if the parameter "Delay scene recall ?" is set to "yes".</p>
Overwrite values stored in the device during download ?	yes no	<p>During storage of a scene, the scene values (current states of the outputs concerned) are stored in the device memory. To prevent the stored values from being replaced during ETS programming of the application or of the parameters by the originally programmed scene switching states, the actuator can inhibit overwriting of the scene values (setting: "no"). As an alternative, the original values can be reloaded into the device during each ETS programming (setting: "yes").</p>

Scene X activatable by scene number (scene number "0" = scene deactivated) <i>X = depending on the scene (1...8)</i>	0...64; 1* <i>*: The predefined scene number is dependent on the scene (1...8).</i>	The actuator distinguishes between up to 8 different scenes which are recalled via the scene extension object or stored. The datapoint type of the extension object permits addressing of up to 64 scenes max. This parameter defines the scene number (1...64) which is used to address the internal scene. A setting of "0" deactivates the corresponding scene.
Switching state for scene X <i>X = depending on the scene (1...8)</i>	switching on switching off	This parameter is used for programming the switching command which is executed when the scene is recalled.
Storage function for scene X <i>X = depending on the scene (1...8)</i>	yes no	The "yes" setting enables the storage function of the scene. If the function is enabled, the current logic switching state (on / off) can be stored internally via the extension object during reception of a scene storage telegram. If "no" is selected, the storage telegrams are rejected.

 Ax – Supplementary functions (x = number of output 1 ... max. 16. / All outputs can be parameterized independently / Only visible in switching mode!)

Selection of supplementary function	<p>no supplementary function</p> <p>disabling function</p> <p>forced-control position</p>	<p>This parameter can be used to define and to enable the supplementary function. The disabling function can only be parameterized as an alternative to the forced-control position function.</p> <p> The forced-control position function is only parameterizable in the ETS3.0d and onwards!</p>
Polarity of disable object	<p>0 = enabled; 1 = disabled</p> <p>1 = enabled; 0 = disabled</p>	<p>This parameter defines the polarity of the disabling object.</p> <p> After bus voltage return or programming of the application or of the parameters with the ETS, the disabling function is always deactivated (object value "0"). In the inverted setting ("1 = enabled; 0 = disabled"), a "0" telegram update must first be sent after the initialization before the disabled state can be activated.</p>
Behaviour at the beginning of the disabling function	<p>no change of switching state</p> <p>switching off</p> <p>switching on</p> <p>blinking</p>	<p>The behaviour of the output at the beginning of the disabling function can be parameterized.</p> <p>At the beginning of the disabling function, the relay of the output shows no reaction and remains in the current switching state. Thereafter, the output is locked.</p> <p>The output switches off at the beginning of the disabling function and goes into lock.</p> <p>The output switches on at the beginning of the disabling function and goes into lock.</p> <p>The output blinks on and off during disabling and is locked during this time. The blinking time is generally parameterized for all outputs under "General". During blinking, the logic switching state is "ON - 1".</p> <p> An output disabled via the bus can still be operated by hand!</p> <p> This parameter is only visible, if the parameter "Selection of supplementary function is set to "disabling function".</p>

Behaviour at the end of the disabling function:

The behaviour of the output at the end of the disabling function can be parameterized.

no change of switching state

At the end of disabling, the internal switching state is not changed. Thereafter, the output is again enabled.

switching off

At the end of disabling, the switching state is set to off. The output is re-enabled.

switching on

At the end of disabling, the switching state is set to on. The output is re-enabled.

setting tracked state

At the end of disabling, the last switching state existing before the disabling function or the switching state internally tracked during the disabling function will be set. In this case, residual times of time functions or of the staircase functions will be tracked as well, if they have not completely elapsed at the time of re-enabling the disabling function.

blinking

At the end of disabling, the output blinks on and off and is re-enabled. Blinking persists until a new switching state is set. The blinking time is generally parameterized for all outputs under "General". During blinking, the logic switching state is "ON - 1".

- The states set at the end of the disabling function do not start time functions. Exception: "set tracked state").
- If a logic operation is parameterized, the state is evaluated in the logic operation function in such a way as if the state had been updated via the "Switching" object (no evaluations of time functions).
- This parameter is only visible, if the parameter "Selection of supplementary function is set to "disabling function".

Behaviour at the end of
the forced-control
position

The behaviour of the output at the beginning of a forced-control position function is directly determined by the forced-position telegram. The behaviour of the output at the end of the forced-control position function can be parameterized.

tracking the switching state

At the end of the forced-control position function, the output will be set to the switching state last existing before forced control or to the one tracked internally while forced control was active. In this case, residual times of time functions or of the staircase functions will be tracked as well, if they have not completely elapsed at the time of re-enabling the disabling function.

**no change of switching
state**

At the end of the forced-control position function, the internal switching state will not be changed. Thereafter, the output is again enabled.

switching off

At the end of the forced-control position function, the switching state is set to off. The output is re-enabled.

switching on

At the end of the forced-control position function, the switching state is set to on. The output is re-enabled.

i If a logic operation is parameterized, the state is evaluated in the logic operation function in such a way as if the state had been updated via the "Switching" object (no evaluations of time functions).

Behaviour after bus voltage return		The communication object of the forced-control position function can be initialized after bus voltage return. The switching state of the output can be influenced when the forced-control position function is activated.
	no forced-control position	No forced-control position activated after bus voltage return.
	activate forced-control position, ON	Forced-control position activated. Output re-enabled.
	deactivate forced-control position, OFF	Forced-control position activated. The output will be switched off by forced control.
	state of forced-control as before bus voltage failure	The output is set to the forced control state which was stored in a non-volatile memory at the time of bus voltage failure. After programming of the application or of the parameters with the ETS, the value is internally set to "not active".
		<p><input type="checkbox"/> After programming of the application or of the parameters with the ETS, the forced-control position is always cancelled.</p> <p><input type="checkbox"/> This parameter is only visible, if the parameter "Selection of supplementary function" is set to "forced-control position".</p>
Logic operation function ?	yes	This parameter can be used to enable the logic operation function (setting "yes"). After enabling, the logic operation object and the parameters of the function are visible.
	no	
		<input type="checkbox"/> The parameter is fixed to "no", when the staircase lighting timer or the cyclical monitoring functions are enabled.

Type of logic operation	<p>OR</p> <p>AND</p> <p>AND with feedback</p>	<p>This parameter defines the type of the logic operation.</p> <p>i "AND with feedback:" With a logic object = "0", the output is <u>always</u> "0" (logic AND). In this case, the feedback signal from the output to the "switching" input will directly reset this input when it is being set. Only if the logic operation object = "1", can the output adopt the logic state "1" after a new "1" has been received on the "Switching" input.</p> <p>i This parameter is only visible, if the parameter "Logic operation function ?" is set to "yes".</p>
Value of logic operation object after bus voltage return	<p>0 (OFF)</p> <p>1 (ON)</p>	<p>If logic operation is enabled, the parameter can be used to determine the value with which the logic operation object will be initialized after bus voltage return.</p> <p>i This parameter is only visible, if the parameter "Logic operation function ?" is set to "yes".</p>
Value of logic operation object after ETS download	<p>0 (OFF)</p> <p>1 (ON)</p>	<p>If logic operation is enabled, the parameter can be used to determine the value with which the logic operation object will be initialized after ETS programming.</p> <p>i This parameter is only visible, if the parameter "Logic operation function ?" is set to "yes".</p>